



ASCAMAS

INSTRUMENTOS CIRÚRGICOS

CATÁLOGO GERAL DE INSTRUMENTOS CIRÚRGICOS

Instagram 
ascamas.cirurgicos

ascamas

Linked in 
ascamas

Rua Major Sertório, 349 - 6º andar - Sala D6 - V. Buarque - São Paulo
vendas@ascamas.com.br

Tels.: 11 2762-9867 / 11 98485-9844 / 11 99108-5734



Fundada em 2015, a empresa ASCAMAS trouxe inovação para o segmento com o intuito de colocar o cliente e suas necessidades sempre em primeiro lugar.

Analisando a demanda do mercado que, cada vez mais, tende pela praticidade do dia a dia, nossa equipe loca caixas cirúrgicas e instrumentais. Com essa iniciativa, mais uma vez nossa empresa disparou no mercado como a maior empresa de locação de instrumentos e caixas cirúrgicas no Brasil.

Contamos hoje com uma grande gama de clientes em diversas regiões do país, por isso, venha conhecer nosso trabalho e a excelência de nossos materiais que contam com 10 anos de garantia contra defeitos de fabricação.

Tels.: 11 2762-9867 / 98485-9844 / 99108-5734

ÍNDICE

A

ABAIXADORES DE LÍNGUA

BRUENINGS 09

ABRIDORES DE BOCA

JENNINGS 09

MOLT 09

ABRIDORES DE GESSO

HENNING 09

AFASTADORES

ADSON 10

AUFRICHT 10

WORFF 10

ALM 10

BAUFOUR 10

BENNET 11

DESMARRES 11

BECKMAN 11

CASTROVIEJO 11

FARABEUF 11

FINOCHIETTO 11

GOSSET 12

HOHMANN 12

GELPI 12

HENLEY 12

ISRAEL 13

KOCHER 13

LANGENBECK 13/14

LOVE 14

MEAD 14

AFASTADORES

OLLIER 15

RICHARDSON 15

MILLIN 15

SEN-MULLER 15

VOLKMANN 15/16/17

WEITLANER 17

AGULHAS

LUCAE 17/18

OBWEGESER 18

ANUSCÓPIOS

BENSAUDE 18

LUCAE 18

ALICATES

CORTE LATERAL 18

PITANGA 18

ASPIRADORES

YANKAUER 18

B

BLEFAROSTATOS

BARRAQUER 19

CASTROVIEJO 19

COOK 19

PARK 19

BISTURIS

ESMARCH 19

COOK 19

ABRAHAM 20

ÍNDICE

C

CABOS

CABO INTERMEDIÁRIO	20
CABO PARA BISTURI	20
CABO PARA ESPELHO DE LARINGE	21
CABO PARA SERRA GIGLI	21

CÂNULAS

BALIU	21
FRAZIER COM MANDRIL	21

CAUTÉRIO

WADSWORTH-TOOD	21
----------------	----

CIZALHAS

LISTON	21/22
LUER GOIVA	22
RUSKIN	22/23
SEMB	23
STILLE LISTON	23
STILLE LISTON KEY	23
STILLE LUER	24
STILLE LUER PARA GESSO	24

CLIPS

MAYO	24
------	----

COSTOTOMOS

COLLIN	24
GLUCK	24
MODELO SIMPLES	25
SAUERBRUCH	25

CRANEOCLASTO

BRAUM	25
-------	----

CURETAS

BRUNS	25
NOVAK	25
RECAMIER	26
SCHROEDER	26
MEYHOEFER	26
WALLICH	27

D

DESCOLADORES

COLVER	27
--------	----

DILATADORES

DESJARDIM	27
WILLIGER	27
HURD	27
LA-BORDE	27
SIMS	28
VELA DE HEGAR	28
TROUSSEAU	28
WYLIE	28

E

ESPÁTULAS

FLEXÍVEL	28
REVERDIN	29
TUFFIER	29

ESPECÍMETROS

IWANSON	29
---------	----

ESPÉCULOS

AURICULAR HARTMANN	29
--------------------	----

ÍNDICE

E

ESPÉCULOS

AURICULAR POLITZER	29
COLLIN	30
KILLIAN	30
HARTMANN	30
MATHIEU	30
PITANGA	31
SIMS	31

ESTILETES

BIOLIVAR	31
ESTILETE PARA ALGODÃO	31

F

FACAS

BALLENGER	31
BECKMAN	31
CATLIN	32
COLLIN	32

FLEBOEXTRATOR

FLEBOEXTRATOR	32
---------------	----

FÓRCEPS

AUXILIAR PARA PARTO	32
LEE	32
KEILAND	32
PIPER	33

FORMÃO

LAMBOTTE	33
STILLE	33

G

GANCHOS

BRAUM	34
GILLIES	34
HARTMAN	34
JOSEPH	34
MODENHAUER	34
ZALFAL	34

H

HISTERÔMETROS

COLLIN	35
SIMS	35

M

MARTELOS

BABINSKI	35
BUCK	35
DEJERINE	35
HAJEK	36
MEAD	36
NEUFIELD	36
TEYLOR	36
UNIVERSAL	36
WILLIGER	36

MENISCÓSTOMOS

SMILLIE	37
---------	----

P

PELVIMETROS

COLLIN	37
MARTIN	37

ÍNDICE

P

PERFURADORES

HUDSON	37
SMILLIE	37/38

PINÇAS

ABADIE	38
ADSON	38
ADSON BROWN	38
ALLIS	38
ANATÔMICA DISSECÇÃO	39
ANATÔMICA PONTA FINA	39
ANATÔMICA DENTE DE RATO	39
ASCH	39
AUTO CENTRANTE	39
AUXILIAR DE SUTURA	39
BABCOCK	40
BACKHAUS	40
BERNHARD	40
BEYER	40
BISHOP	40
BOZEMANN	41
BULDOG	41
BRUENINGS	41
CHERON	41
CHEVALIER	41/42
CITELLI	42
CLAMP	42
CLÍNICA P/ ALGODÃO	42
COLIBRI BARRAQUER	42
COLLIN CORAÇÃO	42
COLLIN P/ CURATIVO	43
COLLIN P/ INSTRUMENTOS	43
COLLIN OVAL	43
COTTLE WALSHAM	43

PINÇAS

CRAFOORD	44
CRILE	44
CUSHING	44
DANDY	45
DARTIGUES	45
DE BAKEY	456
DOYEN PARA CAMPO	45
DOYEN ATRAUMA	45
DOYEN INTESTINAL E COPROSTASI	46
DUCK BILL	46
DUVAL	46
FARABEUF LAMBOTTE	46/47
FARABEUF VAN-BUREN	47
FAURE	47
FERGUSSON	47
FERRIS SMITH KERRISON	47/48
FOERSTER	48
GLOVER	48
GRUENWALD	49
GUYON	49
HALSTEAD MOSQUITO	49
HALSTEAD MICRO	50
HARTMANN P/ CURATIVO	50
HARTMANN P/ CORPO ESTRANHO	50/51
HISTOLOGICA	51
JONES	52
KELLY	51/52
KERRISON	53
KOCHER HEMOSTICA	53
KOCHER INTESTINAL E COPROSTASI	53
KOCHER - ATRAUMA	53/54
LAMBOTTE	54
LANE	54

ÍNDICE

PINÇAS

LEKSELL	54
LOWMANN	54
LUCAE	55
LUER SIMPLES	55
LUER DUPLA ARTICULAÇÃO	55
MAGIL	55
MARTIN	56
MATHIEU	56
MENKEN OU KOGAN	56
MICHEL	56
MARTEL	56
MIXTER	57
MOYNIHAN	57
MUSEUX	57
NELSON	57
PINÇA P/ BIOPSIA MICRO	57/58
PATA DE GATO	58
PAYR	58
PEAN	59
PELKMANN	59
PENNINGTON	59
PERRY	59
POZZI	59
PROFESSOR MEDINA	60
RANDALL	59
REINOLD	60
ROCHESTER CARMALT	60
ROCHESTER PEAN	60
ROMPE BOLSA	60
ROWE	61
RUSKIN	61
SATINSKY	61
SCHIMIDT	62

PINÇAS

SCHUBERT	62
SCHUMACHER	62
SEMB	62
SNELLEN	62/63
TAKAHASHI	63
THOMAS GAYLOR	63
TROELTSCH	63
YEOMAN	63
WERTHEIM - CULLEN	64
WINTER	64

PORTA AGULHAS

CASTROVIEJO	64/65
CRILE WOOD	65
DERF	65
ERMOLD	65
MATHIEU	65
MAYO HEGAR	66
PORTA AGULHA P/ FIO DE AÇO	66

PORTA AGULHAS DE TUNGSTÊNIO

GILLIES	66
MAYO HEGAR	66
MATHIEU	66
OLSEN HEGAR	66

PORTA GILETE

CASTROVIEJO	67
-------------	----

PUNCH

KEYS	67
------	----

ÍNDICE

R

RASPAS

AUFRICHT	68
COTTLE	68
LEWIS	68

RETOSCÓPIO

PITANGA	68
---------	----

ROTATIVA

BALIU	68
-------	----

RUGINAS

DOYEN	68
FARABEUF	69
LAMBOTTE	69

S

SACA FIBROMA

DOYEN	69
-------	----

SERRAS

CHARRIERE	69
GIGLI	69
JOSEPH	69
LANGENBECK	70
MATHIEU	70
WEISS	70
WIGMORES	70

SERRA NÓ

BRUENINGS	70
-----------	----

SONDAS

ITARD	71
TENTACANULA	71

T

TENTACULA

TENTACANULA	71
-------------	----

TESOURAS

BALIU	71
BARRAQUER	71
BELLUCCI	71/72
CASTROVIEJO	72
CIRURGICA	72/73
ENTERÓTOMO	73
GOLDMAN FOX	73
HEYMANN	73
IRIS OU GENGIVA	74
JOSEPH	74
KILNER	74
LISTER	74
MAYO STILLE	75
METZEMBAUM	75
NOYES IRIS	75
OURO	76
POTTS - SMITH	76
SCHMACHER	77
SIMS	77
SMITH	77
SPENCER	77
STEVENS	77
TESOURA P/ CORDÃO UMBILICAL	78
VANNAS	78
WESTCOTT	78

V

VALVULAS

AUVARD	79
DOYEN	79
DOYEN SUB PUBIANA	79
PARA AFASTADOR BAUFOR	79

Os produtos exibidos nesse catálogo estão dispostos em ordem alfabética.

ABAIXADOR DE LÍNGUA

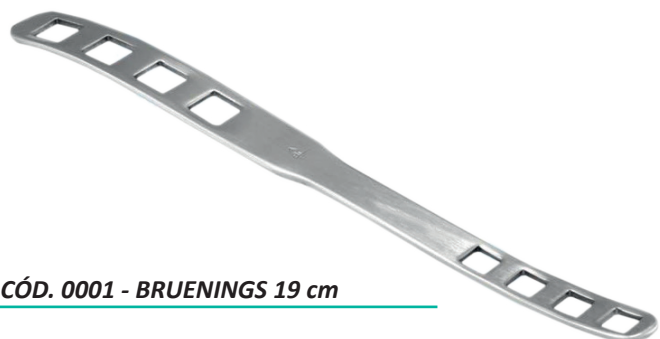

CÓD. 0001 - BRUENINGS 19 cm



CÓD. 0597 - MC-IVOR SEM SUCÇÃO c/3 LÂMINAS
CÓD. 0921MC-IVOR COM SUCÇÃO c/3 LÂMINAS

ABRIDORES DE BOCA



CÓD. 0978 - JENNINGS 11 cm



CÓD. 0981 - WHITEHEAD 11 cm COM TRAVA



CÓD. 0565 - MOLT 10 cm INFANTIL

ABRIDORES DE GESSO



CÓD. 0002 - HENNING 27 cm

ABRIDORES DE GESSO



CÓD. 0003 - WORFF 23 cm



CÓD. 0386 - ALM 4 x 4 AGUDO PARA PLÁSTICO

AFASTADORES



CÓD. 0522 - HOFRICHT 10 CM PARA CIRURGIA NASAL



CÓD. 0004 - BAUFOUR ABDOMINAL COM VÁLVULA CURVA 45 X 80

CÓD. 0561 - BAUFOUR ABDOMINAL COM VÁLVULA CURVA 20 X 25



CÓD. 0385 - ADSON BABY 16 cm ARTICULADO PARA USO GERAL



CÓD. 0988 - BAUFOUR ABDOMINAL COM VÁLVULA RETA 70 X 100

AFASTADORES



CÓD. 0936 - BENNET 24 cm PARA CIRURGIA ÓSSEA



CÓD. 0006 - FARABEU PARA CIRURGIA

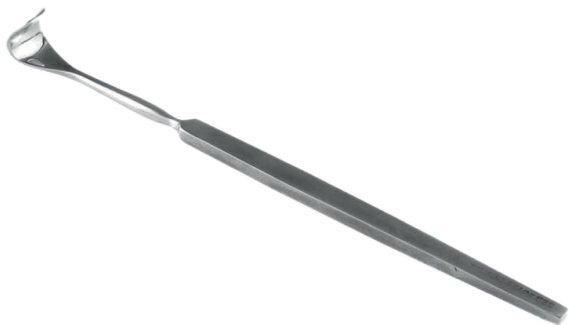

CÓD. 0517 - DESMARRES N1 - 12mm P/ USO GERAL
CÓD. 0518 - DESMARRES N2 - 14mm P/ USO GERAL
CÓD. 0519 - DESMARRES N1 - 16mm P/ USO GERAL
CÓD. 0520 - DESMARRES N1 - 18mm P/ USO GERAL



CÓD. 0006 - FARABEU BABY (7x10 mm) P/ USO GERAL
CÓD. 0007 - FARABEU INFANTIL (10x120 mm) P/ USO GERAL
CÓD. 0008 - FARABEU ADULTO (13x125 mm) P/ USO GERAL
CÓD. 0498 - FARABEU EXTRA (15x150 mm) P/ USO GERAL
CÓD. 0499 - FARABEU EXTRA GRANDE (20x180 mm) PARA USO GERAL

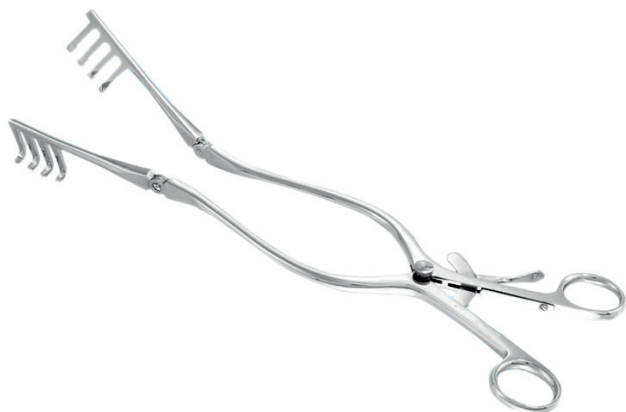

CÓD. 0005 - BECKMAN ADSON 4x4 31 cm P/ USO GERAL



CÓD. 0562 - FINOCHIETTO BABY 18 x 22 - 8 cm P/ TORAX
CÓD. 0563 - FINOCHIETTO 25 x 40 - 13 cm P/ TORAX
CÓD. 0009 - FINOCHIETTO 38 x 45 - 16 cm P/ TORAX
CÓD. 0010 - FINOCHIETTO 40 x 65 - 18 cm P/ TORAX

AFASTADORES



CÓD. 0364 - GOSSET 12cm - ABDOMINAL c/ DUPLO BARRAMENTO
CÓD. 0012 - GOSSET 16cm - ABDOMINAL c/ DUPLO BARRAMENTO
CÓD. 0013 - GOSSET 24cm - ABDOMINAL c/ DUPLO BARRAMENTO
CÓD. 0014 - GOSSET 30cm - ABDOMINAL c/ DUPLO BARRAMENTO



CÓD. 1138 - HENLEY - 16,5 - 3x4 c/ VÁLVULA 16x19 cm



CÓD. 0932 - HOHMANN - 8mm - PONTA FINA p/ CIRÚRGIA ÓSSEA
CÓD. 0933 - HOHMANN - 18mm - PONTA FINA p/ CIRÚRGIA ÓSSEA
CÓD. 0934 - HOHMANN - 43mm - PONTA FINA p/ CIRÚRGIA ÓSSEA
CÓD. 0935 - HOHMANN - 70mm - PONTA FINA p/ CIRÚRGIA ÓSSEA



CÓD. 0479 - ISRAEL c/ 4 DENTES - 23cm p/ USO GERAL



CÓD. 0011 - GELPI - 18cm - ABDOMINAL



CÓD. 0480 - ISRAEL c/ 5 DENTES - 23cm p/ USO GERAL

AFASTADORES



CÓD. 0482 - KOCHER c/ 2 DENTES ROMBO 22cm p/ USO GERAL



CÓD. 0483 - KOCHER c/ 3 DENTES ROMBO 22cm p/ USO GERAL



CÓD. 0484 - KOCHER c/ 4 DENTES ROMBO 22cm p/ USO GERAL



CÓD. 0485 - KOCHER c/ 6 DENTES ROMBO 22cm p/ USO GERAL



CÓD. 0481 - ISRAEL c/ 6 DENTES - 23cm p/ USO GERAL



CÓD. 0593- LANGENBECK 35x7mm - 21 cm - p/ USO GERAL

AFASTADORES

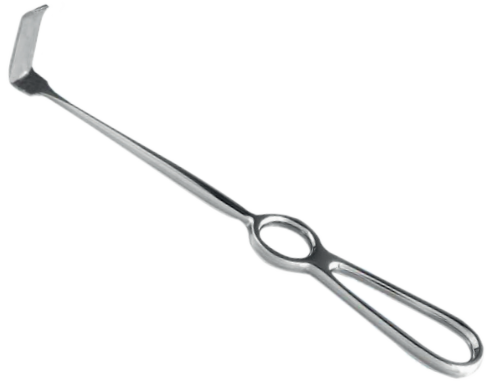

CÓD. 0595 - LANGENBECK - 35 x 15mm - 21cm p/ USO GERAL



CÓD. 0558 - LOVE RETO p/ CIRURGIA GERAL



CÓD. 0559 - LOVE 45° ANGULADO p/ CIRURGIA GERAL



CÓD. 0560 - LOVE 60° - ACOTOVELADO RETO p/ CIRURGIA GERAL



CÓD. 0594 - LOVE 35x10mm - 21cm p/ CIRURGIA GERAL



CÓD. 1080 - MEAD

AFASTADORES



CÓD. 0486 - OLLIER c/ 2 DENTES 22,5 CM p/ USO GERAL



CÓD. 0487 - OLLIER c/ 4 DENTES 22,5cm p/ USO GERAL



CÓD. 0015 - RICHARDSON 25cm 24x20 p/ CIRURGIA GERAL
CÓD. 0016 - RICHARDSON 25cm 33x29 p/ CIRURGIA GERAL
CÓD. 0017 - RICHARDSON 25cm 40x38 p/ CIRURGIA GERAL
CÓD. 0018 - RICHARDSON 25cm 50x22 p/ CIRURGIA GERAL



CÓD. 0019 - SEN-MULLER DUPLO 17cm - p/ USO GERAL



CÓD. 0995 - MILLIN c/ 5 LÂMINAS ABDOMINAL E VESICAL



CÓD. 0488 - VOLKMANN c/ 2 DENTES ROMBO 22cm p/ USO GERAL

AFASTADORES

CÓD. 0490 - VOLKMANN com 4 DENTES ROMBO
22cm p/ USO GERAL



CÓD. 0491 - VOLKMANN com 6 DENTES ROMBO
22cm p/ USO GERAL



CÓD. 0492 - VOLKMANN com 8 DENTES ROMBO
22cm p/ USO GERAL



CÓD. 0493 - VOLKMANN com 2 DENTES FINO
22cm p/ USO GERAL



CÓD. 0489 - VOLKMANN com 3 DENTES ROMBO
22cm p/ USO GERAL



CÓD. 0494 - VOLKMANN com 3 DENTES FINO
22cm p/ USO GERAL

AFASTADORES



CÓD. 0496 - VOLKMANN com 6 DENTES ROMBO
22cm p/ USO GERAL



CÓD. 0497 - VOLKMANN com 8 DENTES FINO 22cm p/ USO GERAL



CÓD. 1140 - WEITLANER 2x3 DENTES 10,5 cm p/ USO GERAL
CÓD. 0020 - WEITLANER 2x3 DENTES 14 cm p/ USO GERAL
CÓD. 0021 - WEITLANER 3x4 DENTES 18 cm p/ USO GERAL
CÓD. 0022 - WEITLANER 3x4 DENTES 20 cm p/ USO GERAL

AGULHAS

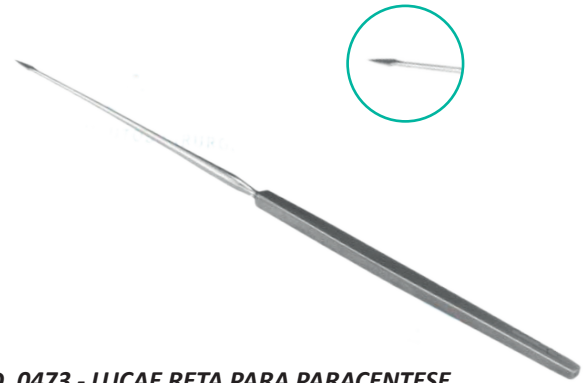

CÓD. 0473 - LUCAE RETA PARA PARACENTESE



CÓD. 0495 - VOLKMANN com 4 DENTES FINO 22cm p/ USO GERAL



CÓD. 0474 - LUCAE ANGULADA PARA PARACENTESE

AGULHAS



CÓD. 0566 - OBWEGESER - 23 cm p/ PASSAR FIOS

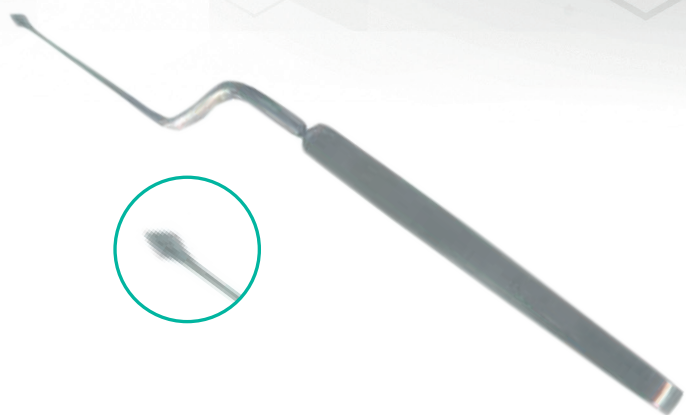

CÓD. 0475 - LUCAE BAIONETA P/ PARACENTESE

ANUSCÓPIOS



CÓD. 1133 - BENSUADE ADULTO (22 x 70mm)
CÓD. 1117 - BENSUADE INFANTIL (16 x 70mm)



CÓD. 1052 - PITANGA Nº1 (19 x 85mm)
CÓD. 1053 - PITANGA Nº2 (22 x 85mm)
CÓD. 1054 - PITANGA Nº3 (25 x 85mm)

ALICATE



CÓD. 0023 - CORTE LATERAL EM AÇO INOX PARA OSSO

ASPIRADORES



CÓD. 1002 - YANKAUER c/ 24cm PARA SUCCÃO
CÓD. 0024 - YANKAUER c/ 27cm PARA SUCCÃO

BLEFAROSTATOS

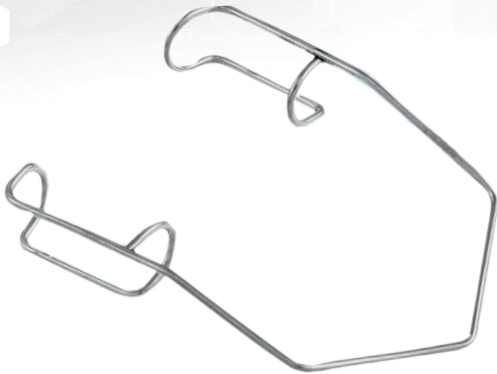

CÓD. 0972 - BARRAQUER (COLIBRI) 3cm P/ OFTALMOLOGIA
CÓD. 0973 - BARRAQUER (COLIBRI) 4cm P/ OFTALMOLOGIA

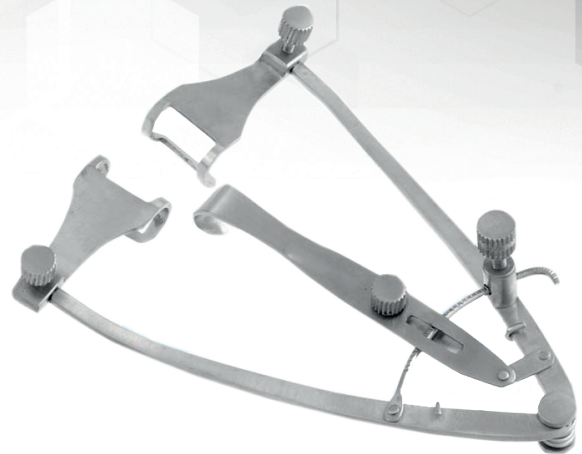

CÓD. 0974 - PARK 8cm PARA OFTALMOLOGIA

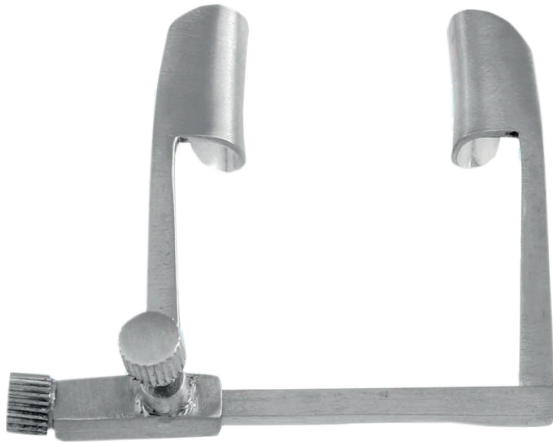

CÓD. 0975 - COOK 4cm P/ OFTALMOLOGIA
CÓD. 0976 - COOK 5cm P/ OFTALMOLOGIA



CÓD. 0650 - CASTROVIEJO 8cm PARA MICRO CIRURGIA

BISTURIS



CÓD. 0906 - ESMARCH 18 cm PARA GESSO



CÓD. 0571 - BRUENINGS - 23 cm AMIGDALAS

BISTURIS



CÓD. 0570 - ABRAHAM 21cm PARA AMIGDALAS

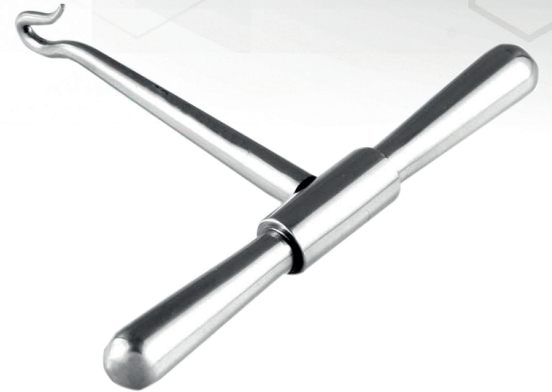

CÓD. 0640 - CABO PARA SERRA GIGLI

CABOS



CÓD. 1102 - CABO INTERMEDIÁRIO COM REGULAGEM 6cm PARA OTORRINO



CÓD. 0027 - CABO PARA BISTURI Nº 7 INOX 17cm P/ LÂMINAS Nº 10 a 17



CÓD. 0026 - CABO PARA BISTURI Nº 4 INOX 14cm PARA LÂMINAS Nº 18 a 36



CÓD. 0920 - CABO PARA BISTURI Nº 3 e 4 DUPLO INOX 17cm P/ LÂMINAS Nº 10 a 36

CABOS



**CÓD. 1101 - CABO PARA ESPELHO DE LARINGE
COM REGULAGEM 10,5cm**



**CÓD. 0025 - CABO PARA BISTURI Nº 3 INOX
13cm P/ LÂMINAS Nº 10 a 17**

CÂNULA



CÓD. 0034 - BALIU 17cm PARA ASPIRAÇÃO UTERINA

CAUTÉRIO



**CÓD. 0445 - WADSWORTH-TODD BICO DE
PASSARINHO 15cm**

CIZALHAS



**CÓD. 0028 - FRAZIER COM MANDRIL P/ SUCÇÃO 3mm
CÓD. 1118 - FRAZIER COM MANDRIL P/ SUCÇÃO 4mm
CÓD. 1119- FRAZIER COM MANDRIL P/ SUCÇÃO 5mm**

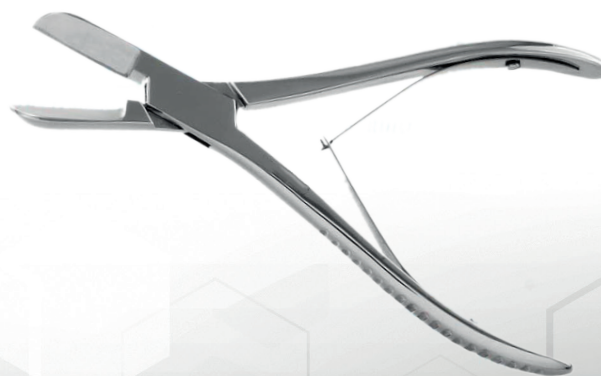

CÓD. 0396 - LISTON 19cm RETA SIMPLES PARA OSSO

CIZALHAS



CÓD. 0633 - LUER GOIVA CURVA 16cm PARA OSSO (ALVEOLÓTOMO)



CÓD. 0634 - LUER GOIVA RETA 16cm P/ OSSO (ALVEOLÓTOMO)



CÓD. 0591 - LUER GOIVA RETA 17cm SIMPLES PARA OSSO



CÓD. 0592 - LUER GOIVA CURVA 17cm SIMPLES P/OSSO



CÓD. 0397 - LISTON 19cm CURVA SIMPLES PARA OSSO



**CÓD. 0598 - RUSKIN LISTON RETA 18,5cm
DUPLA ARTICULAÇÃO**

CIZALHAS



CÓD. 0600 - SEMB RETA 23cm DUPLA ARTICULAÇÃO
CÓD. 0602 - SEMB RETA 27cm DUPLA ARTICULAÇÃO



CÓD. 0601 SEMB CURVA 23cm DUPLA ARTICULAÇÃO
CÓD. 0601 SEMB CURVA 23cm DUPLA ARTICULAÇÃO



CÓD. 0608 - STILLE LISTON RETA 23cm DUPLA ARTICULAÇÃO
CÓD. 0029 - STILLE LISTON RETA 27cm DUPLA ARTICULAÇÃO



CÓD. 0609 - STILLE LISTON CURVA 23cm DUPLA ARTICULAÇÃO
CÓD. 0030- STILLE LISTON CURVA 27cm DUPLA ARTICULAÇÃO



CÓD. 0599 - RUSKIN LISTON CURVA 18,5 cm DUPLA ARTICULAÇÃO

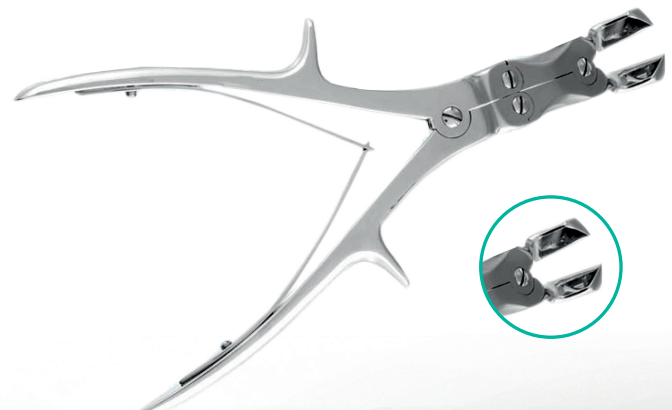

CÓD. 0031 - STILLE LISTON KEY 27cm DUPLA ARTICULAÇÃO

CIZALHAS



CÓD. 0033 - STILLE LUER CURVA 23cm DUPLA ARTICULAÇÃO



CÓD. 0398 - STILLE PARA GESSO 26cm
CÓD. 0398 - STILLE PARA GESSO 37cm



CÓD. 0032 - STILLE UER RETA 23 cm DUPLA ARTICULAÇÃO

CLIPS



CÓD. 0863 - MAYO - 14cm (PORTA INSTRUMENTOS)

COSTOTOMOS



CÓD. 0068 - COLLIN 19cm P/ CIRURGIA TÓRAX E PULMÃO



CÓD. 0039 - GLUCK 19cm PARA CIRURGIA TÓRAX E PULMÃO
CÓD. 0040 - GLUCK 22cm PARA CIRURGIA TÓRAX E PULMÃO

COSTOTOMOS



CÓD. 0663 - SAUERBRUCH 26cm
PARA CIRURGIA TÓRAX E PULMÃO



CÓD. 0069 MODELO SIMPLES 22cm c/ MOLA PARA CIRURGIA
TÓRAX E PULMÃO

CRANEOCLASTO



CÓD. 1122 - BRAUM 42cm PARA OBSTETRÍCIA

CURETAS



CÓD. 0047- NOVAK PARA BIOPSIA

CURETAS

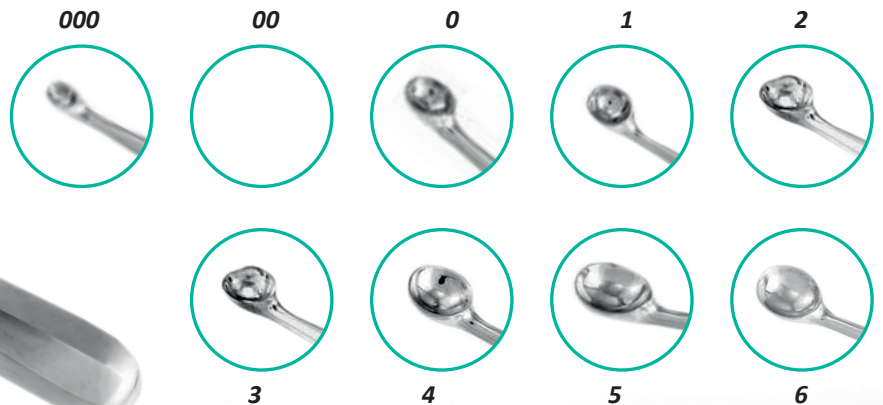

CÓD.0917 - BRUNS Nº 000 P/ CIRURGIA ÓSSEA 17cm
CÓD.0918 - BRUNS Nº 00 P/ CIRURGIA ÓSSEA 17cm
CÓD.0919 - BRUNS Nº 0 P/ CIRURGIA ÓSSEA 17cm
CÓD.0041 - BRUNS Nº 1 P/ CIRURGIA ÓSSEA 17cm
CÓD.0042 - BRUNS Nº 2 P/ CIRURGIA ÓSSEA 17cm
CÓD.0043 - BRUNS Nº 3 P/ CIRURGIA ÓSSEA 17cm
CÓD.0044 - BRUNS Nº 4 P/ CIRURGIA ÓSSEA 17cm
CÓD.0045 - BRUNS Nº 5 P/ CIRURGIA ÓSSEA 17cm
CÓD.0046 - BRUNS Nº 6P/ CIRURGIA ÓSSEA 17cm

CURETAS

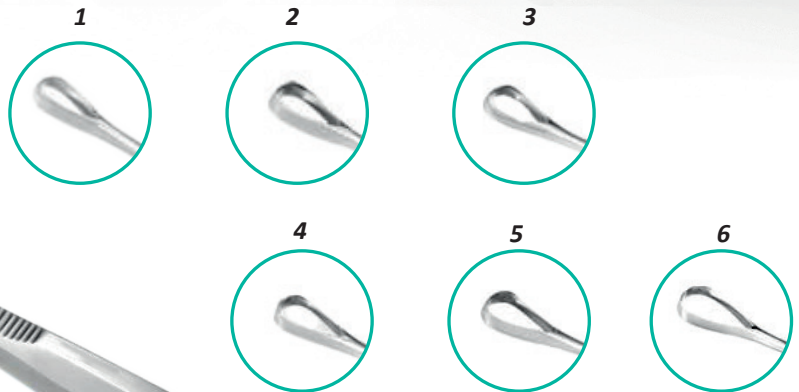

- CÓD.0048 - RECAMIER GINECOLÓGICO Nº 1 31cm**
CÓD.0049 - RECAMIER GINECOLÓGICO Nº 2 31cm
CÓD.0050 - RECAMIER GINECOLÓGICO Nº 3 31cm
CÓD.0051 - RECAMIER GINECOLÓGICO Nº 4 31cm
CÓD.0052 - RECAMIER GINECOLÓGICO Nº 5 31cm
CÓD.0053 - RECAMIER GINECOLÓGICO Nº 6 31cm

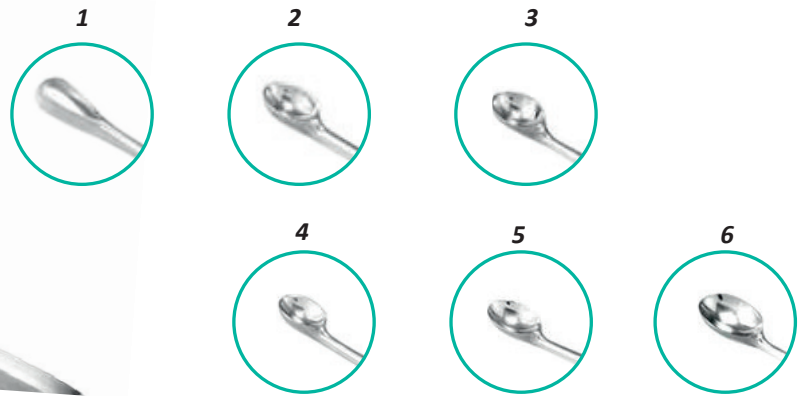

- CÓD.0054 - SCHROEDER GINECOLÓGICO Nº 1 30cm**
CÓD.0055 - SCHROEDER GINECOLÓGICO Nº 2 30cm
CÓD.0056 - SCHROEDER GINECOLÓGICO Nº 3 30cm
CÓD.0057 - SCHROEDER GINECOLÓGICO Nº 4 30cm
CÓD.0058 - SCHROEDER GINECOLÓGICO Nº 5 30cm
CÓD.0059 - SCHROEDER GINECOLÓGICO Nº 6 30cm

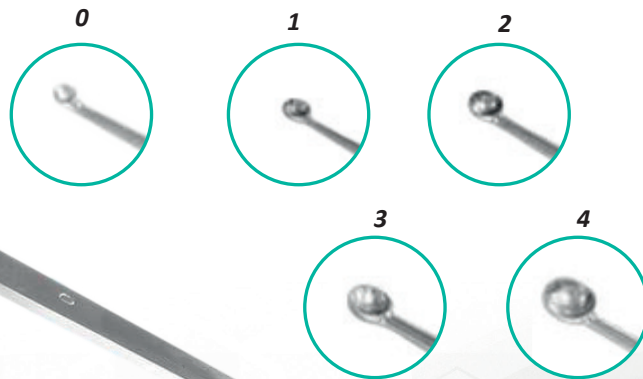
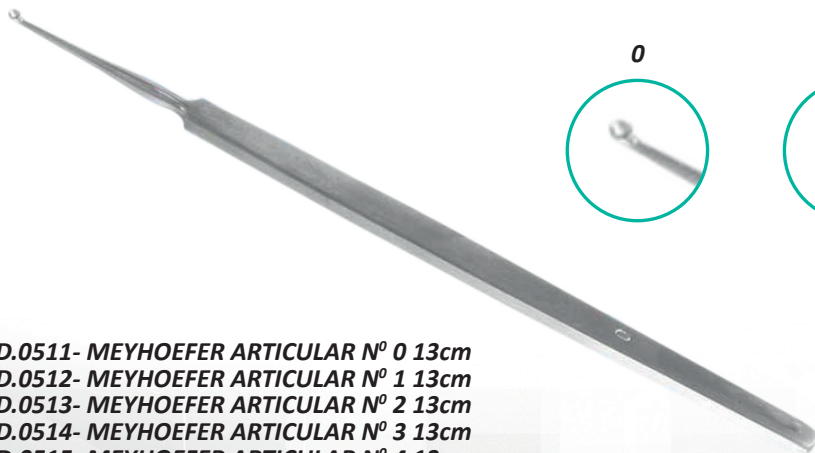

- CÓD.0511- MEYHOEFER ARTICULAR Nº 0 13cm**
CÓD.0512- MEYHOEFER ARTICULAR Nº 1 13cm
CÓD.0513- MEYHOEFER ARTICULAR Nº 2 13cm
CÓD.0514- MEYHOEFER ARTICULAR Nº 3 13cm
CÓD.0515- MEYHOEFER ARTICULAR Nº 4 13cm

CURETAS



CÓD. 0382 - WALLICH 42cm Nº 1 P/ ABORTO E PLACENTA
CÓD. 0383 - WALLICH 42cm Nº 2 P/ ABORTO E PLACENTA
CÓD. 0384 - WALLICH 42cm Nº 3 P/ ABORTO E PLACENTA



CÓD. 0516 - WILLIGER DUPLA PARA OSSO 13cm

DESCOLADORES



CÓD. 0569 - COLVER PARA AMIGDALAS 23cm



CÓD. 0470 - HURD P/ AMIGDALAS E PALATINO 23cm

DILATADORES



CÓD. 0073 - DESJARDIM DUCTO BILIAR JOGO C/3 PEÇAS



CÓD. 0074 - LA-BORDE TRAQUEAL 15cm C/ 3 RAMOS

DILATADORES



CÓD. 0406 - SIMS C/ 3 RANIS UTERINO 27cm



CÓD. 0075 - TROUSSEAU C/ 2 RAMOS TRAQUEAL 15cm



- CÓD. 0076 - VELA DE HEGAR UTERINO Nº 1
- CÓD. 0077 - VELA DE HEGAR UTERINO Nº 2
- CÓD. 0078 - VELA DE HEGAR UTERINO Nº 3
- CÓD. 0079 - VELA DE HEGAR UTERINO Nº 4
- CÓD. 0080 - VELA DE HEGAR UTERINO Nº 5
- CÓD. 0081 - VELA DE HEGAR UTERINO Nº 6
- CÓD. 0082 - VELA DE HEGAR UTERINO Nº 7
- CÓD. 0083 - VELA DE HEGAR UTERINO Nº 8
- CÓD. 0084 - VELA DE HEGAR UTERINO Nº 9
- CÓD. 0085 - VELA DE HEGAR UTERINO Nº 10
- CÓD. 0086 - VELA DE HEGAR UTERINO Nº 11
- CÓD. 0087 - VELA DE HEGAR UTERINO Nº 12
- CÓD. 0088 - VELA DE HEGAR UTERINO Nº 13
- CÓD. 0089 - VELA DE HEGAR UTERINO Nº 14
- CÓD. 0090 - VELA DE HEGAR UTERINO Nº 15
- CÓD. 0091 - VELA DE HEGAR UTERINO Nº 16
- CÓD. 0092 - VELA DE HEGAR UTERINO Nº 17
- CÓD. 0093 - VELA DE HEGAR UTERINO Nº 18
- CÓD. 0094 - VELA DE HEGAR UTERINO Nº 19
- CÓD. 0095 - VELA DE HEGAR UTERINO Nº 20
- CÓD. 0096 - VELA DE HEGAR UTERINO Nº 21
- CÓD. 0097 - VELA DE HEGAR UTERINO Nº 22
- CÓD. 0098 - VELA DE HEGAR UTERINO Nº 23
- CÓD. 0374 - VELA DE HEGAR UTERINO Nº 24
- CÓD. 0375 - VELA DE HEGAR UTERINO Nº 25



CÓD. 0405 - WYLIE C/ 2 RAMOS UTERINO 31cm

ESPÁTULAS



- CÓD. 0100 - FLEXÍVEL ABDOMINAL 300 x 20 mm
- CÓD. 0101 - FLEXÍVEL ABDOMINAL 300 x 25 mm
- CÓD. 0102 - FLEXÍVEL ABDOMINAL 300 x 30 mm
- CÓD. 0103 - FLEXÍVEL ABDOMINAL 300 x 35 mm
- CÓD. 0104 - FLEXÍVEL ABDOMINAL 300 x 40 mm
- CÓD. 0105 - FLEXÍVEL ABDOMINAL 300 x 45 mm
- CÓD. 0106 - FLEXÍVEL ABDOMINAL 300 x 50 mm

ESPÁTULAS



CÓD. 0108 - REVERDIN ABDOMINAL BAIONETA

ESPECÍMETROS



**CÓD. 0564 - IWANSON INOX 0/10 mm
INSTRUMENTO PARA MEDIR**

ESPÉCULOS



CÓD. 0109 - TUFFIER ABDOMINAL 200 x 18 x 24mm



**CÓD. 1134 - AURICULAR HARTMANN 3mm -
4,5mm - 5,5mm - 6,5 mm**



CÓD. 0107 - REVERDIN ABDOMINAL RETA



**CÓD. 1135 - AURICULAR POLITZER 3mm -
4,5mm - 5,5mm - 6,5 mm**

ESPÉCULOS



CÓD. 0110 - COLLIN VAGINAL PARA VIRGEM



**CÓD. 0111 - COLLIN VAGINAL Nº1 PEQUENO
CÓD. 0112 - COLLIN VAGINAL Nº2 MÉDIO
CÓD. 0113 - COLLIN VAGINAL Nº3 GRANDE**



**CÓD. 0366 - KILLIAN NASAL Nº1 DE 35mm
CÓD. 0367 - KILLIAN NASAL Nº2 DE 50 mm
CÓD. 0368 - KILLIAN NASAL Nº3 DE 75 mm
CÓD. 0369 - KILLIAN NASAL Nº4 DE 90 mm**



CÓD. 0371 - MATHIEU RETAL TRIVALVE



**CÓD. 0114 - NASAL HARTMANN Nº1 ADULTO
CÓD. 0115 - NASAL HARTMANN Nº2 ADULTO
CÓD. 0116 - NASAL HARTMANN Nº3 ADULTO**



**CÓD. 0060 - NASAL HARTMANN Nº1 INFANTIL
CÓD. 0060 - NASAL HARTMANN Nº2 INFANTIL**

ESPÉCULOS



CÓD. 0994 - PITANGA SANTOS RETAL 13 cm



CÓD. 0370 - SIMS RETAL

ESTILETES

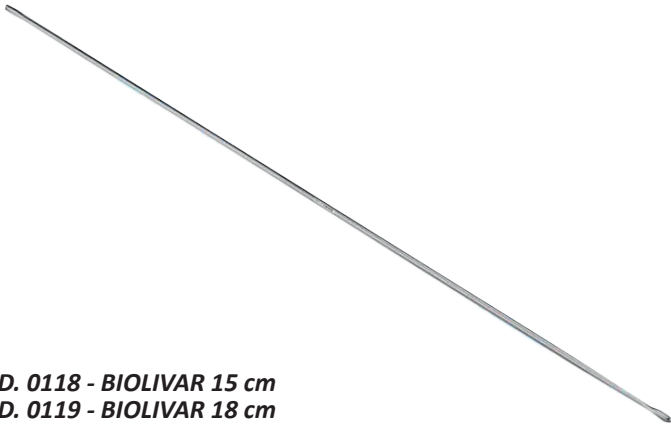

CÓD. 0118 - BIOLIVAR 15 cm
CÓD. 0119 - BIOLIVAR 18 cm
CÓD. 0120 - BIOLIVAR 20 cm



CÓD. 0121 - ESTILETE PARA ALGODÃO 15cm
CÓD. 0122 - ESTILETE PARA ALGODÃO 20cm
CÓD. 0123 - ESTILETE PARA ALGODÃO 28cm UTERINO

FACAS



CÓD. 0124 - BALLENGER P/ SEPTO BAIONETA Nº1 20 cm
CÓD. 0125 - BALLENGER P/ SEPTO BAIONETA Nº2 20 cm



CÓD. 0126 - BECKMAN P/ ADENOIDE Nº1 22cm
CÓD. 0127 - BECKMAN P/ ADENOIDE Nº2 22cm
CÓD. 0128 - BECKMAN P/ ADENOIDE Nº3 22cm
CÓD. 0129 - BECKMAN P/ ADENOIDE Nº4 22cm
CÓD. 0130 - BECKMAN P/ ADENOIDE Nº5 22cm
CÓD. 0131 - BECKMAN P/ ADENOIDE Nº6 22cm

FACAS



CÓD. 0407 - CATLIN LÂMINA 13 cm P/ AMPUTAÇÃO
CÓD. 0408 - CATLIN LÂMINA 16 cm P/ AMPUTAÇÃO
CÓD. 0409 - CATLIN LÂMINA 19 cm P/ AMPUTAÇÃO
CÓD. 0410 - CATLIN LÂMINA 22 cm P/ AMPUTAÇÃO



CÓD. 0411 - COLLIN LÂMINA 12 cm P/ AMPUTAÇÃO
CÓD. 0412 - COLLIN LÂMINA 15 cm P/ AMPUTAÇÃO
CÓD. 0413 - COLLIN LÂMINA 18 cm P/ AMPUTAÇÃO
CÓD. 0414 - COLLIN LÂMINA 23 cm P/ AMPUTAÇÃO

FLEBOEXTRATOR

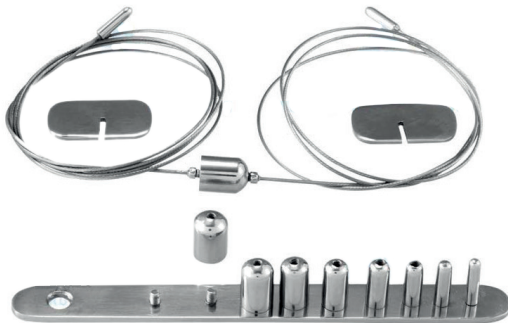

CÓD. 0639 - FLEBOEXTRATOR CONJUNTO C/ 9 OLIVAS DE 4 a 12mm
1 VARETA EM CABO DE AÇO INOX ESPESSURA DE 1mm e COMPRIMENTO DE 1m
1 VARETA EM CABO DE AÇO INOX ESPESSURA DE 1mm e COMPRIMENTO DE 80cm

FÓRCEPS

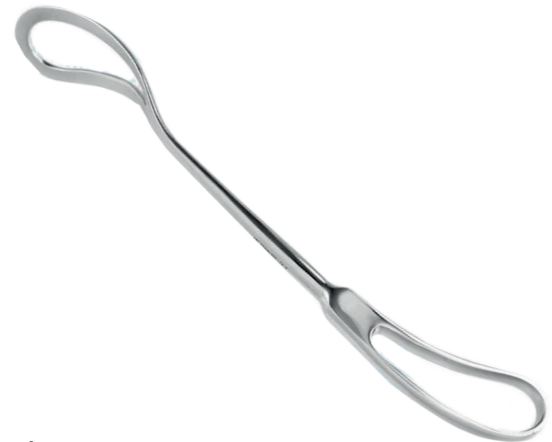

CÓD. 0993 - AUXILIAR PARA PARTO 36 cm

FÓRCEPS



COD. 0134 - KEILAND PARA OBSTRETRICIA 39 cm



CÓD. 0133 - LEE P/ OBSTRETRICIA 37 cm

FÓRCEPS



CÓD. 0135 - PIPER PARA OBSTETRICIA 44 cm



CÓD. 0136 - SIMPSON P/ OBSTETRICIA 30 cm
CÓD. 0137 - SIMPSON P/ OBSTETRICIA 35 cm

FORMÃO



CÓD. 0911 - LAMBOTTE 25mm RETO P/ CIRURGIA ÓSSEA
CÓD. 0913 - LAMBOTTE 30mm RETO P/ CIRURGIA ÓSSEA
CÓD. 0915 - LAMBOTTE 38mm RETO P/ CIRURGIA ÓSSEA

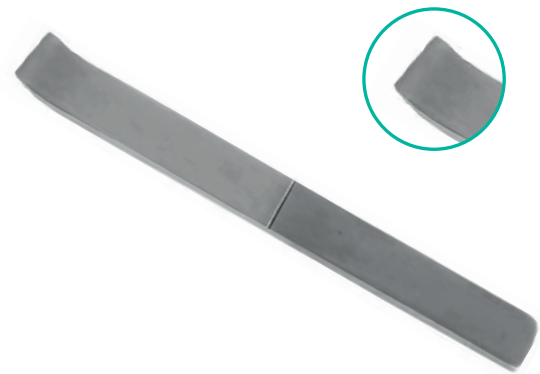

CÓD. 0912 - LAMBOTTE 25mm CURVO P/ CIRURGIA ÓSSEA
CÓD. 0914 - LAMBOTTE 30mm CURVO P/ CIRURGIA ÓSSEA
CÓD. 0916 - LAMBOTTE 38mm CURVO P/ CIRURGIA ÓSSEA

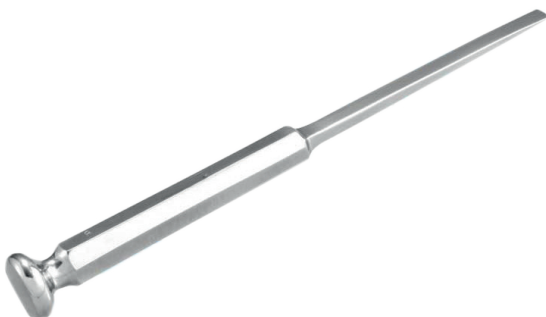

CÓD. 0138 - STILLE DUPLO BIZEL 8mm P/ CIRURGIA ÓSSEA
CÓD. 0139 - STILLE DUPLO BIZEL 10mm P/ CIRURGIA ÓSSEA
CÓD. 0140 - STILLE DUPLO BIZEL 12mm P/ CIRURGIA ÓSSEA
CÓD. 0141 - STILLE DUPLO BIZEL 15mm P/ CIRURGIA ÓSSEA
CÓD. 0142 - STILLE DUPLO BIZEL 20mm P/ CIRURGIA ÓSSEA
CÓD. 0143 - STILLE DUPLO BIZEL 25mm P/ CIRURGIA ÓSSEA



CÓD. 0144 - STILLE GOIVO 8mm P/ CIRURGIA ÓSSEA
CÓD. 0145 - STILLE GOIVO 8mm P/ CIRURGIA ÓSSEA
CÓD. 0146 - STILLE GOIVO 8mm P/ CIRURGIA ÓSSEA
CÓD. 0147 - STILLE GOIVO 8mm P/ CIRURGIA ÓSSEA
CÓD. 0148 - STILLE GOIVO 8mm P/ CIRURGIA ÓSSEA
CÓD. 0149 - STILLE GOIVO 8mm P/ CIRURGIA ÓSSEA

GANCHOS



CÓD. 0123- BRAUM 30 cm P/ DECAPITAÇÃO



CÓD. 0198 - GILLIES DELICADO Nº 1 17cm

CÓD. 0199 - GILLIES DELICADO Nº 2 17cm

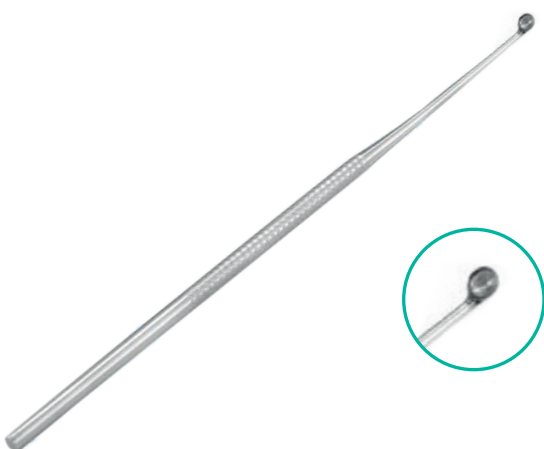

CÓD. 0476 - HARTMAN P/ OUVIDO E CORPO ESTRANHO 17cm

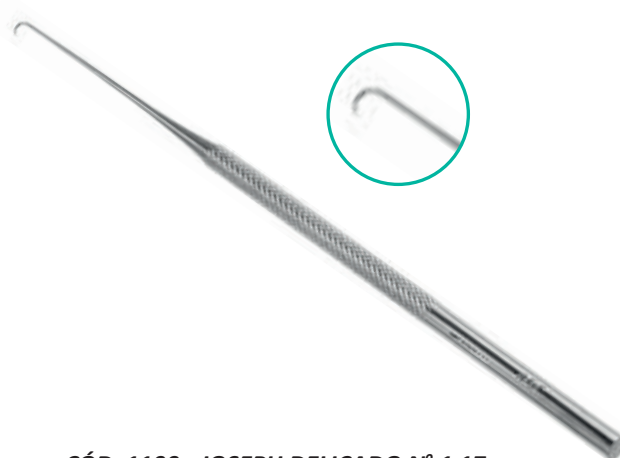

CÓD. 1100 - JOSEPH DELICADO Nº 1 17cm

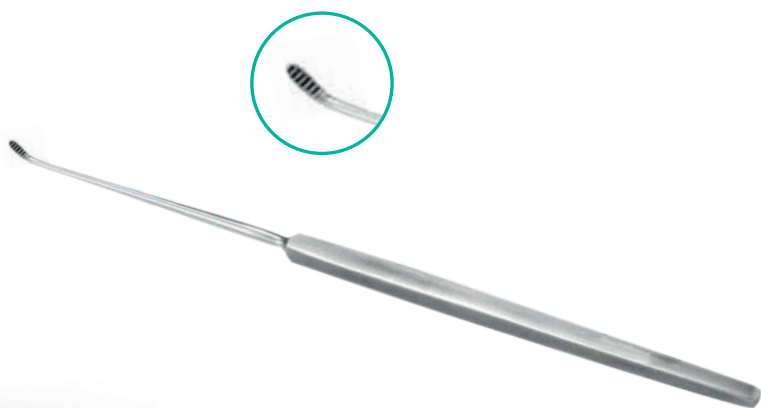

CÓD. 0477 - MODENHAUER P/ OUVIDO E CORPO ESTRANHO 17cm

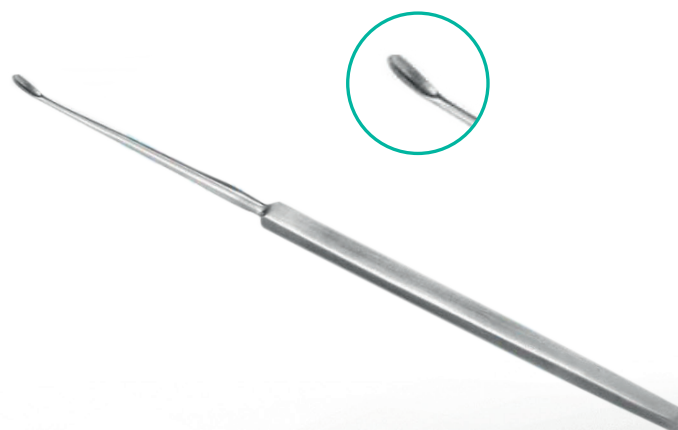

CÓD. 0478 - ZALFAL P/ OUVIDO E CORPO ESTRANHO 17cm

HISTERÔMETROS



CÓD. 0150 - COLLIN 28 cm P/ USO GINECOLÓGICO



CÓD. 0151 - SIMS 27 cm P/ USO GINECOLÓGICO

MARTELOS



CÓD. 0153 - DEJERINE 20cm PERCURSOR E NEUROLÓGICO



CÓD. 0152 - BUCK 18 cm PERCURSOR E NEUROLÓGICO



CÓD. 0431 - BABINSKI 22cm PERCURSOR



CÓD. 0154 - DEJERINE COM AGULHA PERCURSOR E NEUROLÓGICO

MARTELOS



CÓD. 0155 - HAJEK 150g P/ CIRURGIA ÓSSEA
CÓD. 0156 - HAJEK 250g P/ CIRURGIA ÓSSEA



CÓD. 1001 - MEAD C/ BATENTE DE FIBRA



CÓD. 0358 - NEUFIELD PP/ CIRURGIA ÓSSEA



CÓD. 0159 - TEYLOR 18 cm PERCURSOR E NEUROLÓGICO



CÓD. 0890 - UNIVERSAL 500g P/ CIRURGIA ÓSSEA
CÓD. 0891 - UNIVERSAL 750g P/ CIRURGIA ÓSSEA



CÓD. 0157 - WILLIGER 250g P/ CIRURGIA ÓSSEA
CÓD. 0158 - WILLIGER 350g P/ CIRURGIA ÓSSEA

MENISCÓSTOMOS

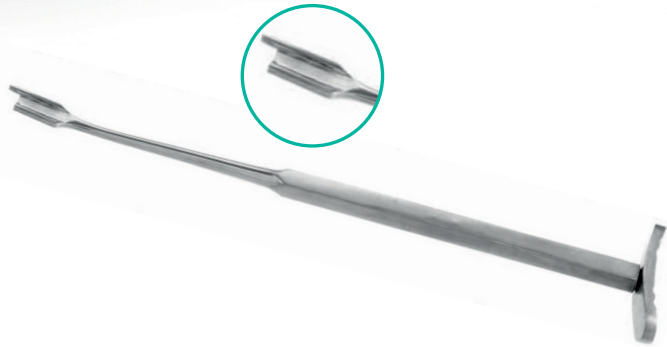

CÓD. 0937 - SMILLIE DIREITO 17cm P/ CIRURGIA ÓSSEA



CÓD. 0939 - SMILLIE DIREITO 17cm P/ CIRURGIA ÓSSEA



CÓD. 0938 - SMILLE ESQUERDO 17cm P/ CIRURGIA ÓSSEA

PELVIMETROS



CÓD. 0160 - COLLIN 35cm - ABERT / 50cm INSTR. P/ MEDIR

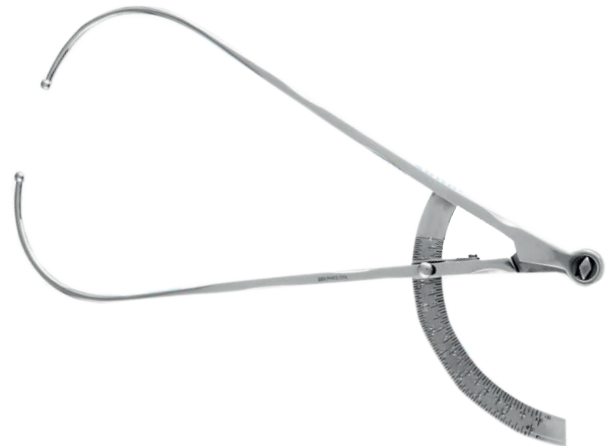

CÓD. 0161 - MARTIN 35cm - ABERT / 50cm INSTR. P/ MEDIR

PERFURADORES

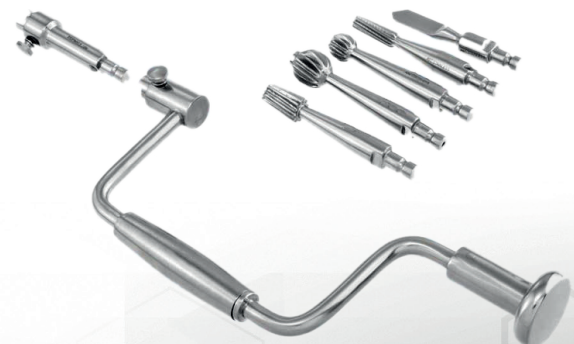

CÓD. 0910 - HUDSON COMPLETO P/ CIRURGIA ÓSSEA

PERFURADORES



CÓD. 0937 - SMILLIE 25cm P/ CRÂNIO - OBSTETRÍCIA

PINÇAS



CÓD. 0162 - ABADIE 27cm P/ ESTÔMAGO E INTESTINO

PINÇAS

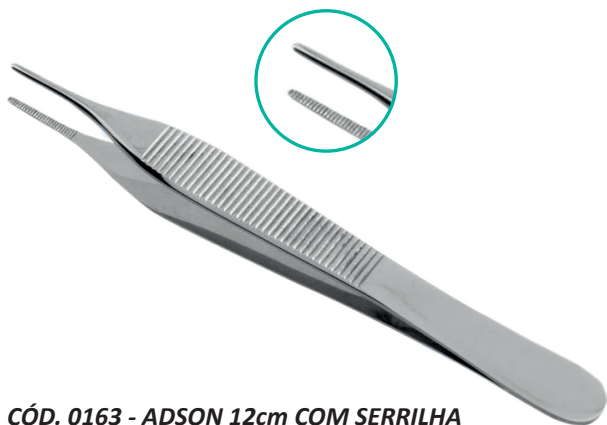

CÓD. 0163 - ADSON 12cm COM SERRILHA
CÓD. 0648 - ADSON 15cm COM SERRILHA
CÓD. 1178 - ADSON 18cm COM SERRILHA

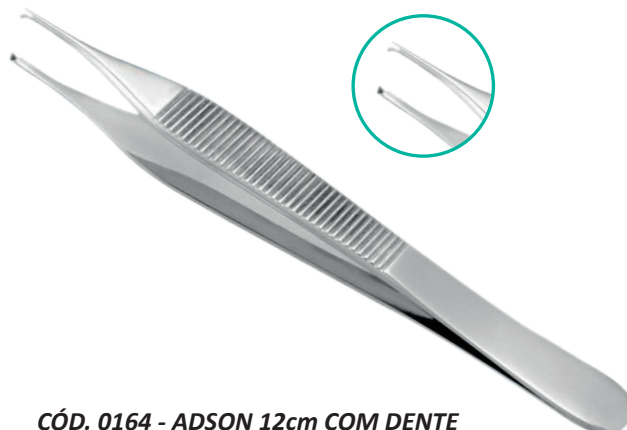

CÓD. 0164 - ADSON 12cm COM DENTE
CÓD. 0649 - ADSON 15cm COM DENTE
CÓD. 1179 - ADSON 18cm COM DENTE

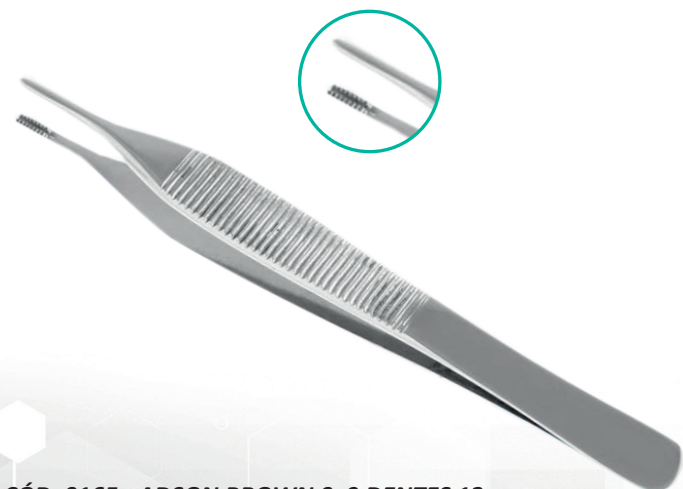

CÓD. 0165 - ADSON BROWN 9x9 DENTES 12cm



CÓD. 0568 - ALLIS BABY 12cm P/ INTESTINO E TECIDO
CÓD. 0166 - ALLIS 15cm P/ INTESTINO E TECIDO
CÓD. 0167 - ALLIS 18cm P/ INTESTINO E TECIDO
CÓD. 0168 - ALLIS 20cm P/ INTESTINO E TECIDO
CÓD. 0169 - ALLIS 25cm P/ INTESTINO E TECIDO

PINÇAS



CÓD. 0651 - ANATÔMICA DISSECÇÃO 10cm
CÓD. 0170 - ANATÔMICA DISSECÇÃO 12cm
CÓD. 0171 - ANATÔMICA DISSECÇÃO 14 cm
CÓD. 0172 - ANATÔMICA DISSECÇÃO 16 cm
CÓD. 0173 - ANATÔMICA DISSECÇÃO 18 cm
CÓD. 0174 - ANATÔMICA DISSECÇÃO 20 cm
CÓD. 0175 - ANATÔMICA DISSECÇÃO 25 cm
CÓD. 1162 - ANATÔMICA DISSECÇÃO 30 cm



CÓD. 0652 - ANATÔMICA DENTE DE RATO 10cm
CÓD. 0176 - ANATÔMICA DENTE DE RATO 12cm
CÓD. 0177 - ANATÔMICA DENTE DE RATO 14 cm
CÓD. 0178 - ANATÔMICA DENTE DE RATO 16 cm
CÓD. 0179 - ANATÔMICA DENTE DE RATO 18 cm
CÓD. 0180 - ANATÔMICA DENTE DE RATO 20 cm
CÓD. 0181 - ANATÔMICA DENTE DE RATO 25 cm
CÓD. 1163 - ANATÔMICA DENTE DE RATO 30 cm



CÓD. 0424- ANATÔMICA PONTA FINA 12cm
CÓD. 0425 - ANATÔMICA PONTA FINA 14cm
CÓD. 0426 - ANATÔMICA PONTA FINA 16cm



CÓD. 0647 - ASCH 23cm P/ SEPTO E CIRURGIA PLÁSTICA



CÓD. 0433 - AUTO CENTRANTE 16cm
CÓD. 0434 - AUTO CENTRANTE 19cm
CÓD. 0435 - AUTO CENTRANTE 24cm
CÓD. 0436 - AUTO CENTRANTE 26cm
CÓD. 0437 - AUTO CENTRANTE 28m



CÓD. 0555 - AUXILIAR DE SUTURA 15cm

PINÇAS

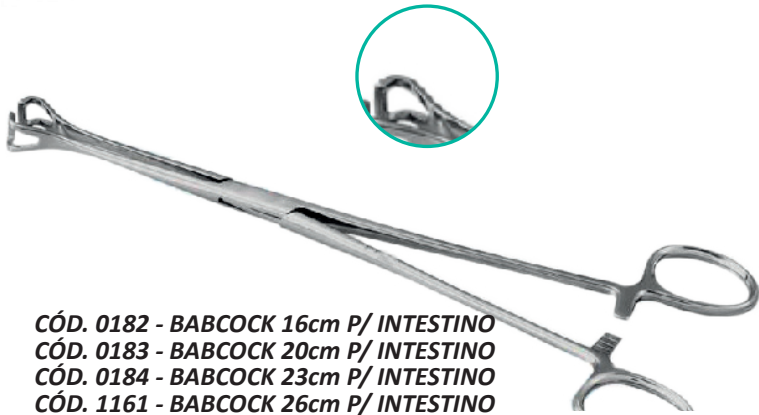

CÓD. 0182 - BABCOCK 16cm P/ INTESTINO
CÓD. 0183 - BABCOCK 20cm P/ INTESTINO
CÓD. 0184 - BABCOCK 23cm P/ INTESTINO
CÓD. 1161 - BABCOCK 26cm P/ INTESTINO



CÓD. 0661 - BACKHAUS 8cm P/ CAMPO
CÓD. 0185 - BACKHAUS 10cm P/ CAMPO
CÓD. 0186 - BACKHAUS 13cm P/ CAMPO
CÓD. 1180 - BACKHAUS 15cm P/ CAMPO



CÓD. 0187- BERNHARD 16cm P/ CAMPO



CÓD. 1072- BEYER 18cm CURVA DUPLA ARTICULAÇÃO



CÓD. 0611- BEYER 18cm SACA BOCADO P/ CAVIDADE

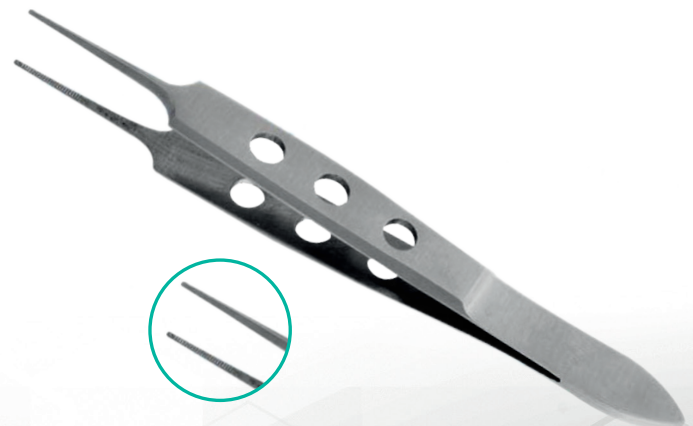

CÓD. 0521 - BISHOP 8cm C/ SERRILHA RETA
P/ MICRO CIRURGIA

PINÇAS



CÓD. 0662 - BOZEMANN 26cm P/ TAPONES



CÓD. 0188 - BRUENINGS Nº1 19cm P/ SEPTO NASAL
CÓD. 0188 - BRUENINGS Nº2 19cm P/ SEPTO NASAL



CÓD. 0190 - BULDOG 4cm RETA DIEFFENBACH
CÓD. 0192 - BULDOG 5cm RETA DIEFFENBACH
CÓD. 0194 - BULDOG 6cm RETA DIEFFENBACH

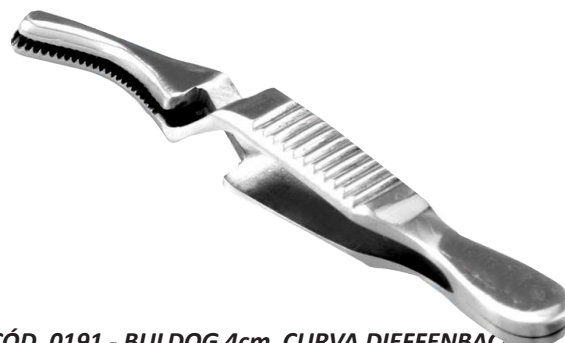

CÓD. 0191 - BULDOG 4cm CURVA DIEFFENBACH
CÓD. 0193 - BULDOG 5cm CURVA DIEFFENBACH
CÓD. 0195 - BULDOG 6cm CURVA DIEFFENBACH

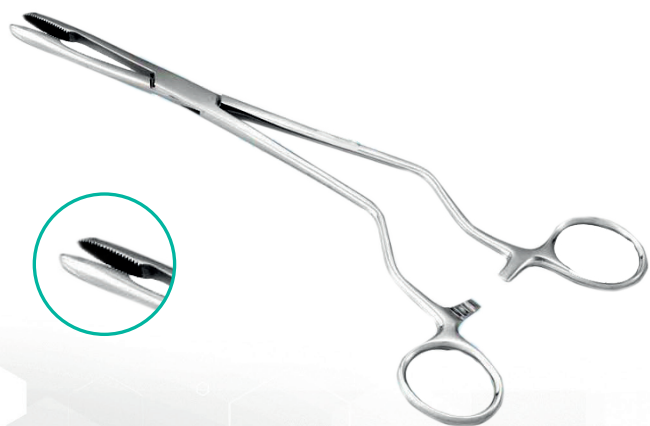

CÓD. 0196 - CHERON 24cm P/ ASSEPSIA E CURATIVO UTERINO

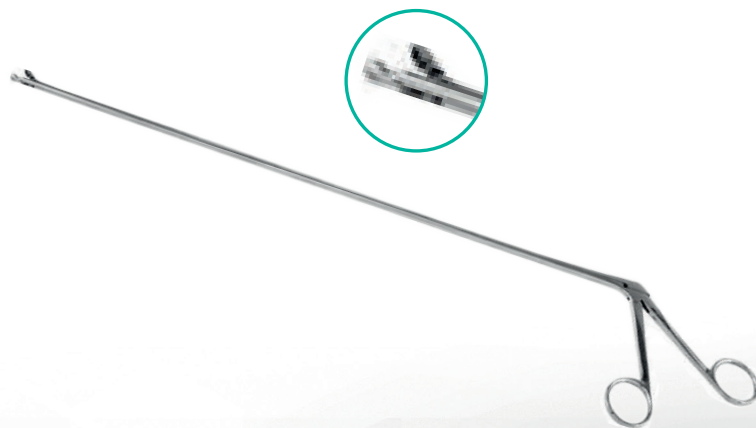

CÓD. 0997 - CHEVALIER JACKSON P/ BIOPSIA 40cm
CÓD. 0998 - CHEVALIER JACKSON P/ BIOPSIA 50cm

PINÇAS

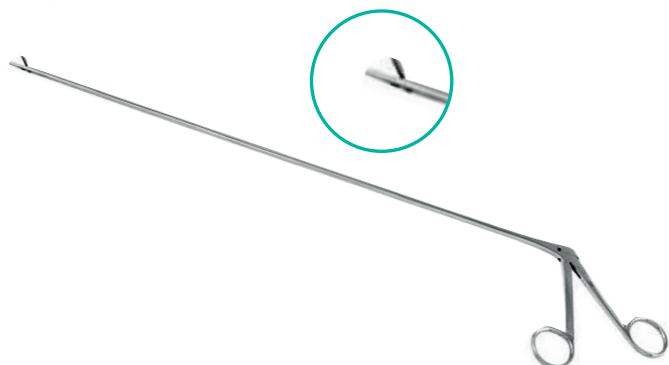

CÓD. 0999 - CHEVALIER JACKSON TIPO JACARÉ 40cm
CÓD. 1000 - CHEVALIER JACKSON TIPO JACARÉ 50cm

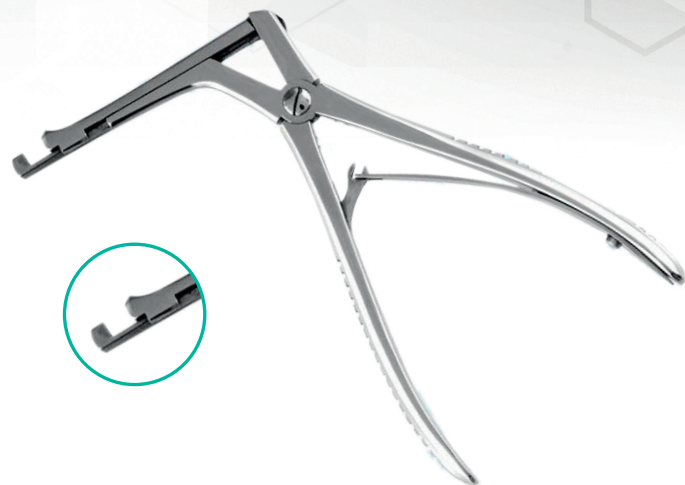

CÓD. 0610 CITELLI 18,5 cm SACA BOCADO P/ CAVIDADES



CÓD. 0438 - CLAMP DE FIXAÇÃO ÓSSEA 160mm (ESPANHOLA)
CÓD. 0439 - CLAMP DE FIXAÇÃO ÓSSEA 220mm (ESPANHOLA)



CÓD. 0197 - CLÍNICA P/ ALGODÃO Nº 17
CÓD. 0554 - CLÍNICA 13 cm P/ ODONTOPEDIATRIA
P/ ALGODÃO



CÓD. 0453 - COLIBRI BARRAQUER 7cm C/ PLATAFORMA



CÓD. 0199 - COLLIN CORAÇÃO 16cm TIRA LINGUA

PINÇAS



CÓD. 0198 - COLLIN 25cm P/ CURATIVO UTERINO



CÓD. 0471 - COLLIN 20cm P/ INSTRUMENTOS 1X2
CÓD. 0472 - COLLIN 25cm P/ INSTRUMENTOS 1X2



CÓD. 1159 - COLLIN OVAL 16cm TIRA LÍNGUA



CÓD. 0613 - COTTLE WALSHAM DIREITA 23cm
P/ SEPTO E PLÁSTICA



CÓD. 0164 - COTTLE WALSHAM ESQUERDA
23cm P/ SEPTO E PLÁSTICA



CÓD. 0615 - COTTLE WALSHAM DIREITA 23cm
P/ SEPTO E PLÁSTICA

PINÇAS

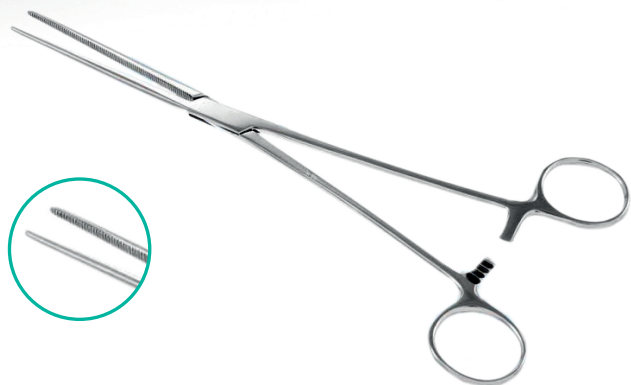

CÓD. 0664 CRAFOORD 24cm RETA BRONQUIOS



CÓD. 065 - CRAFOORD 24cm CURVA P/ BRONQUIOS



CÓD. 0203 - CRILE 14cm RETA (HEMOSTÁTICA)
CÓD. 0205 - CRILE 16cm RETA (HEMOSTÁTICA)



CÓD. 0203 - CRILE 14cm CURVA (HEMOSTÁTICA)
CÓD. 0205 - CRILE 16cm CURVA (HEMOSTÁTICA)



CÓD. 0653 - CUSHING 18cm COM SERRILHA

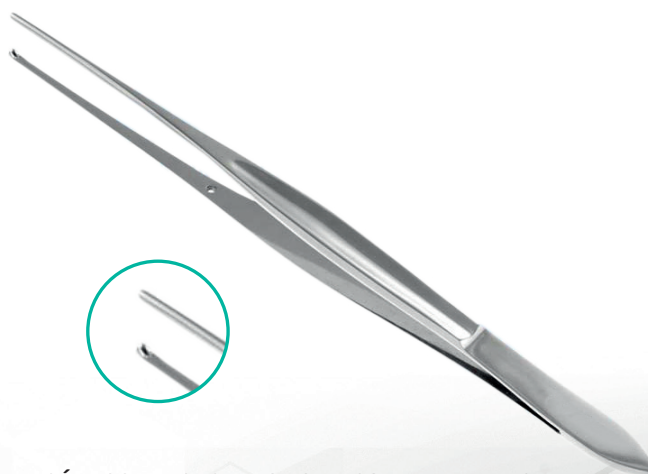

CÓD. 0654 - CUSHING 18cm COM DENTE 1X2

PINÇAS

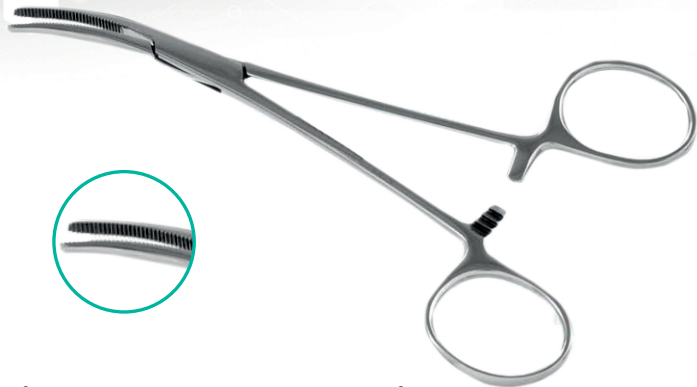

CÓD. 0132 - DANDY 14cm (HEMOSTÁTICA)



CÓD. 0207 - DARTIGUES P/ ÚTERO 24 cm

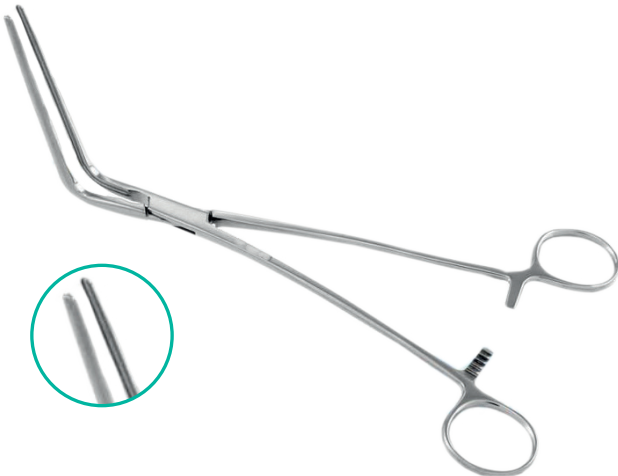

CÓD. 0966 - DE BAKEY ATRAUMA 19cm p/ CARDIOVASCULAR
CÓD. 0967 - DE BAKEY ATRAUMA 23cm p/ CARDIOVASCULAR
CÓD. 0968 - DE BAKEY ATRAUMA 27m p/ CARDIOVASCULAR



CÓD. 0660 - DOYEN 18cm P/ CAMPO



CÓD. 0954 - DOYEN ATRAUMA RETA 16cm GASTRO-INTESTINAL
CÓD. 0955 - DOYEN ATRAUMA RETA 18cm GASTRO-INTESTINAL
CÓD. 0956 - DOYEN ATRAUMA RETA 21cm GASTRO-INTESTINAL
CÓD. 0957 - DOYEN ATRAUMA RETA 23cm GASTRO-INTESTINAL



CÓD. 0958 - DOYEN ATRAUMA CURVA 16cm GASTRO-INTESTINAL
CÓD. 0959 - DOYEN ATRAUMA CURVA 18cm GASTRO-INTESTINAL
CÓD. 0960 - DOYEN ATRAUMA CURVA 21cm GASTRO-INTESTINAL
CÓD. 0961 - DOYEN ATRAUMA CURVA 23cm GASTRO-INTESTINAL

PINÇAS



CÓD. 0208 - DOYEN 25cm RETA INTESTINAL E COPROSTASI



CÓD. 0209 - DOYEN 25cm CURVA INTESTINAL E COPROSTASI

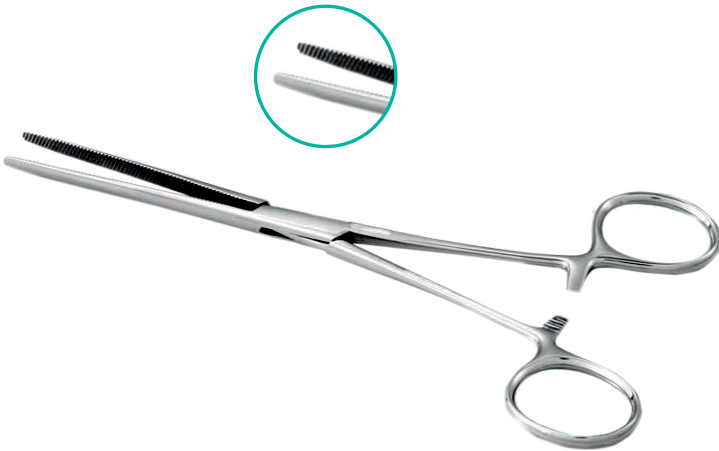

CÓD. 0210 - DOYEN-BABY 18cm RETA INTESTINAL E COPROSTASI
CÓD. 0211 - DOYEN-BABY 18cm RETA INTESTINAL E COPROSTASI



CÓD. 0432 - DUCK BILL GOIVA 23cm



CÓD. 0253-DUVAL COLLIN 20 cm P/ INTESTINO



CÓD. 0212 - FARABEUF LAMBOTTE 26cm S/ CREMALHEIRA P/ OSSO

PINÇAS



**CÓD. 0213 - FARABEUF LAMOTTE 26cm C/
CREMALHEIRA P/ OSSO**



CÓD. 0402 - FARABEUF VAN-BUREN 23cm P/ CIRURGIA ÓSSEA



CÓD. 0214 - FAURE 22cm P/ ARTÉRIA UTERINA



CÓD. 0215 - FAURE 24cm P/ BIOPSIA UTERINA



CÓD. 0403 - FERGUSSON 21cm P/ CIRURGIA ÓSSEA



**CÓD. 0580 - FERRIS SMITH KERRISON 3mm BOCA P/ CIMA
CÓD. 0581 - FERRIS SMITH KERRISON 5mm BOCA P/ CIMA**

PINÇAS



CÓD. 0582 - FERRIS SMITH KERRISON 3mm BOCA P/ BAIXO
CÓD. 0583 - FERRIS SMITH KERRISON 5mm BOCA P/ BAIXO



CÓD. 0584 - FERRIS SMITH KERRISON 3mm BOCA 40°
CÓD. 0585 - FERRIS SMITH KERRISON 5mm BOCA 40°



CÓD. 0667 - FOERSTER 16cm RETA P/ CURATIVO
CÓD. 0216 - FOERSTER 18cm RETA P/ CURATIVO
CÓD. 0669 - FOERSTER 20cm RETA P/ CURATIVO
CÓD. 0218 - FOERSTER 24cm RETA P/ CURATIVO



CÓD. 0668 - FOERSTER 16cm CURVA P/ CURATIVO
CÓD. 0217 - FOERSTER 18cm CURVA P/ CURATIVO
CÓD. 0670 - FOERSTER 20cm CURVA P/ CURATIVO
CÓD. 0219 - FOERSTER 24cm CURVA P/ CURATIVO

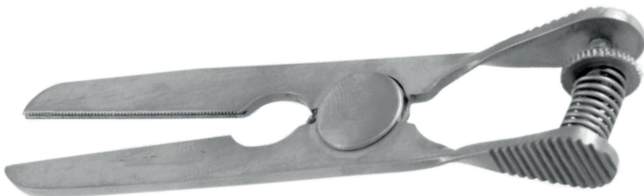

CÓD. 0946 - GLOVER 6cm RETA ATRAUMÁTICA PARA CARDIOVASCULAR
CÓD. 0947 - GLOVER 7cm RETA ATRAUMÁTICA PARA CARDIOVASCULAR
CÓD. 0948 - GLOVER 9cm RETA ATRAUMÁTICA PARA CARDIOVASCULAR
CÓD. 0949 - GLOVER 11cm RETA ATRAUMÁTICA PARA CARDIOVASCULAR



CÓD. 0950 - GLOVER 6cm CURVA ATRAUMÁTICA PARA CARDIOVASCULAR
CÓD. 0951 - GLOVER 7cm CURVA ATRAUMÁTICA PARA CARDIOVASCULAR
CÓD. 0952 - GLOVER 9cm CURVA ATRAUMÁTICA PARA CARDIOVASCULAR
CÓD. 0953 - GLOVER 11cm CURVA ATRAUMÁTICA PARA CARDIOVASCULAR

PINÇAS



CÓD. 0618 - GRUENWALD 26cm BOCA RETA P/ NEURO E LAMINECTOMIA



CÓD. 0619 - GRUENWALD 26cm BOCA PARA CIMA P/ NEURO E LAMINECTOMIA



CÓD. 0620 - GRUENWALD 26cm BOCA P/ BAIXO P/ NEURO E LAMINECTOMIA



**CÓD. 1042 - GUYON 16cm P/ PEDICULO RENAL
CÓD. 0220 - GUYON 22cm P/ PEDICULO RENAL
CÓD. 0221 - GUYON 24cm P/ PEDICULO RENAL**



**CÓD. 0222 - HALSTEAD MOSQUITO 10cm RETA (HEMOSTATICA)
CÓD. 0224 - HALSTEAD MOSQUITO 12cm RETA (HEMOSTATICA)
CÓD. 0427 - HALSTEAD MOSQUITO 18cm RETA (HEMOSTATICA)
CÓD. 0429 - HALSTEAD MOSQUITO 21cm RETA (HEMOSTATICA)**



**CÓD. 0223 - HALSTEAD MOSQUITO 10cm CURVA (HEMOSTATICA)
CÓD. 0225 - HALSTEAD MOSQUITO 12cm CURVA (HEMOSTATICA)
CÓD. 0428 - HALSTEAD MOSQUITO 18cm CURVA (HEMOSTATICA)
CÓD. 0430 - HALSTEAD MOSQUITO 21cm CURVA (HEMOSTATICA)**

PINÇAS



CÓD. 1142 - HARTMANN MICRO 8cm RETA ARTICULAR



CÓD. 1143 - HARTMANN MICRO 8cm CURVA PARA CIMA ARTICULAR

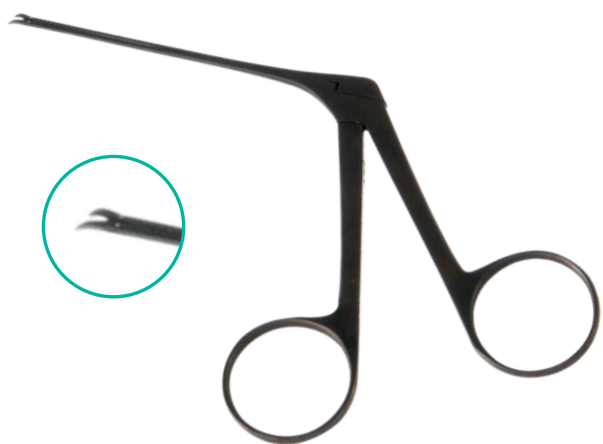

CÓD. 1144 - HARTMANN MICRO 8cm CURVA PARA DIREITA ARTICULAR



CÓD. 1145 - HARTMANN MICRO 8cm CURVA PARA ESQUERDA ARTICULAR



CÓD. 0226 - HARTMANN 15 cm P/ CURATIVO ARTICULAR
CÓD. 0227 - HARTMANN 19 cm P/ CURATIVO ARTICULAR



CÓD. 0228 - HARTMANN 9cm P/ CORPO ESTRANHO C/ SERRILHA
CÓD. 0557 - HARTMANN 14cm P/ CORPO ESTRANHO C/ SERRILHA
CÓD. 0578- HARTMANN 16,5 cm P/ CORPO ESTRANHO C/ SERRILHA

PINÇAS



CÓD. 0229 - HARTMANN 9cm P/ CORPO ESTRANHO COM DENTE



CÓD. 1143 - HARTMANN 20cm P/ CORPO ESTRANHO COM SERRILHA
CÓD. 0065 - HARTMANN 28cm P/ CORPO ESTRANHO COM SERRILHA

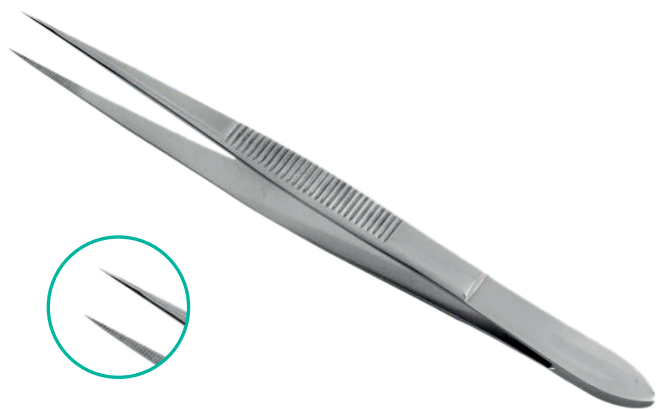

CÓD. 0424 - HISTOLOGICA PONTA FINA 12cm P/ USO GERAL
CÓD. 0425 - HISTOLOGICA PONTA FINA 14cm P/ USO GERAL
CÓD. 0426 - HISTOLOGICA PONTA FINA 16cm P/ USO GERAL



CÓD. 0666 - JONES 9cm PARA CAMPO



CÓD. 0231 - KELLY 14cm RETA (HEMOSTATICA)
CÓD. 0233 - KELLY 16cm RETA (HEMOSTATICA)
CÓD. 0376 - KELLY 18cm RETA (HEMOSTATICA)



CÓD. 0232 - KELLY 14cm CURVA (HEMOSTATICA)
CÓD. 0234 - KELLY 16cm CURVA (HEMOSTATICA)
CÓD. 0377 - KELLY 18cm CURVA (HEMOSTATICA)

PINÇAS



CÓD. 0229 - HARTMANN 9cm P/ CORPO ESTRANHO COM DENTE



CÓD. 1143 - HARTMANN 20cm P/ CORPO ESTRANHO COM SERRILHA
CÓD. 0065 - HARTMANN 28cm P/ CORPO ESTRANHO COM SERRILHA

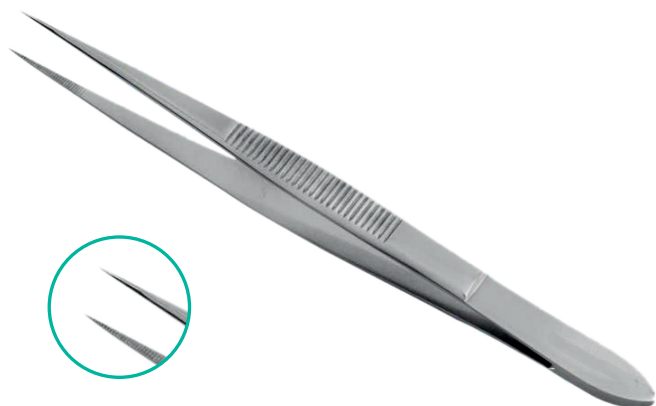

CÓD. 0424 - HISTOLOGICA PONTA FINA 12cm P/ USO GERAL
CÓD. 0425 - HISTOLOGICA PONTA FINA 14cm P/ USO GERAL
CÓD. 0426 - HISTOLOGICA PONTA FINA 16cm P/ USO GERAL



CÓD. 0666 - JONES 9cm PARA CAMPO



CÓD. 0231 - KELLY 14cm RETA (HEMOSTATICA)
CÓD. 0233 - KELLY 16cm RETA (HEMOSTATICA)
CÓD. 0376 - KELLY 18cm RETA (HEMOSTATICA)



CÓD. 0232 - KELLY 14cm CURVA (HEMOSTATICA)
CÓD. 0234 - KELLY 16cm CURVA (HEMOSTATICA)
CÓD. 0377 - KELLY 18cm CURVA (HEMOSTATICA)

PINÇAS



CÓD. 0586 - KERRISON 20cm BOCA 4x4mm P/ MAXILAR E ADENOIDES
CÓD. 0587 - KERRISON 20cm BOCA 5x5mm P/ MAXILAR E ADENOIDES
CÓD. 0588 - KERRISON 20cm BOCA 6x6mm P/ MAXILAR E ADENOIDES



CÓD.0235 - KOCHER 14cm RETA (HEMOSTÁTICA)
CÓD.0237 - KOCHER 16cm RETA (HEMOSTÁTICA)
CÓD.0239 - KOCHER 18cm RETA (HEMOSTÁTICA)
CÓD.0241- KOCHER 20cm RETA (HEMOSTÁTICA)
CÓD.1168 - KOCHER 22cm RETA (HEMOSTÁTICA)
CÓD.1170 - KOCHER 24cm RETA (HEMOSTÁTICA)
CÓD.1172 - KOCHER 26cm RETA (HEMOSTÁTICA)
CÓD.1174 - KOCHER 30cm RETA (HEMOSTÁTICA)



CÓD.0236 - KOCHER 14cm RETA (HEMOSTÁTICA)
CÓD.0238 - KOCHER 16cm RETA (HEMOSTÁTICA)
CÓD.0240 - KOCHER 18cm RETA (HEMOSTÁTICA)
CÓD.0242- KOCHER 20cm RETA (HEMOSTÁTICA)
CÓD.1169 - KOCHER 22cm RETA (HEMOSTÁTICA)
CÓD.1171 - KOCHER 24cm RETA (HEMOSTÁTICA)
CÓD.1173 - KOCHER 26cm RETA (HEMOSTÁTICA)
CÓD.1175 - KOCHER 30cm RETA (HEMOSTÁTICA)

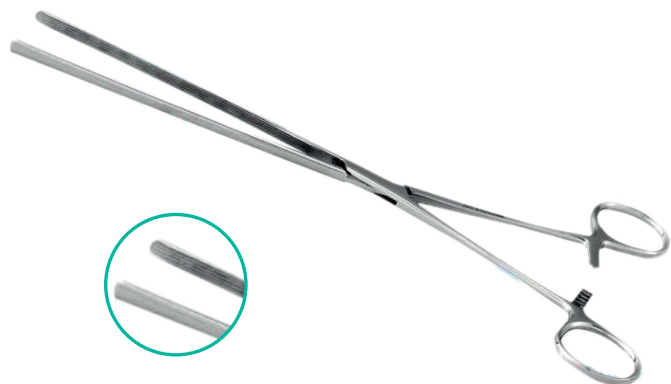

CÓD. 0243 - KOCHER 25cm RETA INTESTINAL E COPROSTASI

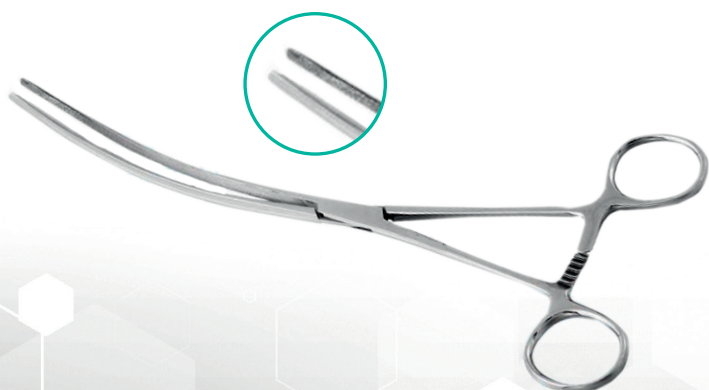

CÓD.0244 - KOCHER 25cm CURVA INTESTINAL E COPROSTASI



CÓD. 0962 - KOCHER ATRAUMA RETA 25cm GASTRO INTESTINAL
CÓD. 0963 - KOCHER ATRAUMA RETA 28cm GASTRO INTESTINAL

PINÇAS

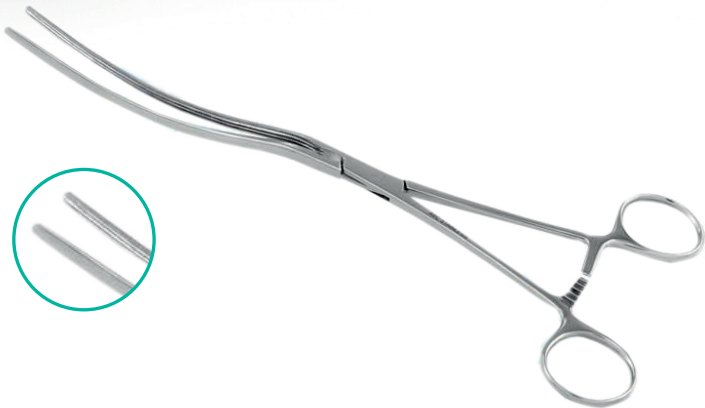

CÓD. 0964 - KOCHER ATRAUMA RETA 25cm GASTRO INTESTINAL
CÓD. 0965 - KOCHER ATRAUMA RETA 28cm GASTRO INTESTINAL



CÓD. 0393 - LAMBOTTE 21cm C/ BOCA MÓVEL P/ CIRURGIA ÓSSEA
CÓD. 0394 - LAMBOTTE 26cm C/ BOCA MÓVEL P/ CIRURGIA ÓSSEA
CÓD. 0395 - LAMBOTTE 31cm C/ BOCA MÓVELP/ CIRURGIA ÓSSEA



CÓD. 0245 - LANE 33cm S/ CREMALHEIRA P/ CIRURGIA ÓSSEA



CÓD. 0246 - LANE 33cm C/ CREMALHEIRA P/ CIRURGIA ÓSSEA



CÓD. 0247 - LEKSELL EM ÂNGULO 24cm P/ CIRURGIA ÓSSEA



CÓD. 1176 - LOWMANN PEQUENA 15cm P/ OSSOS
CÓD. 1177 - LOWMANN PEQUENA 17cm P/ OSSOS
CÓD. 0248 - LOWMANN PEQUENA 17cm P/ OSSOS
CÓD. 0249 - LOWMANN MÉDIA 18,5 cm P/ OSSOS
CÓD. 0250 - LOWMANN GRANDE 20cm P/ OSSOS

PINÇAS



CÓD. 0062 - LUCAE BAIONETA 14,5cm C/ CURATIVO AURICULAR
CÓD. 0063- LUCAE BAIONETA 16,5cm C/ CURATIVO AURICULAR



CÓD. 0591- LUER GOIVA 17cm RETA SIMPLES P/ OSSO



CÓD. 0592 - LUER GOIVA 17cm CURVA SIMPLES P/ OSSO



CÓD. 0032 - LUER GOIVA 23cm RETA DUPLA ARTICULAÇÃO



CÓD. 0033 - LUER GOIVA 23cm CURVA DUPLA ARTICULAÇÃO

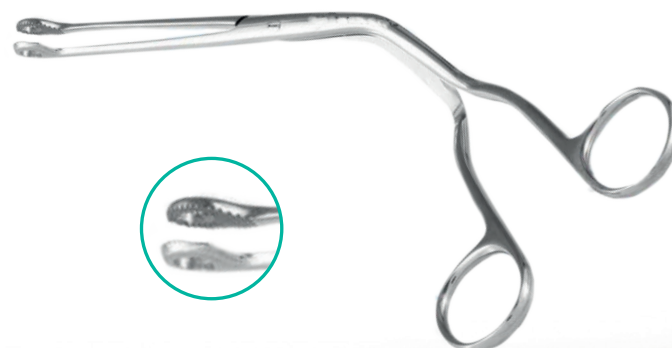

CÓD. 1158 - MAGIL 15cm P/ INTRODUÇÃO DE CATETER
CÓD. 0251 - MAGIL 20cm P/ INTRODUÇÃO DE CATETER
CÓD. 0252 - MAGIL 25cm P/ INTRODUÇÃO DE CATETER

PINÇAS



CÓD. 0387 - MARTIN 19cm PARA MENISCO



CÓD. 0064 - MATHIEU 20cm P/ CORPO ESTRANHO URETRAL
CÓD. 0065 - MATHIEU 28cm P/ CORPO ESTRANHO URETRAL

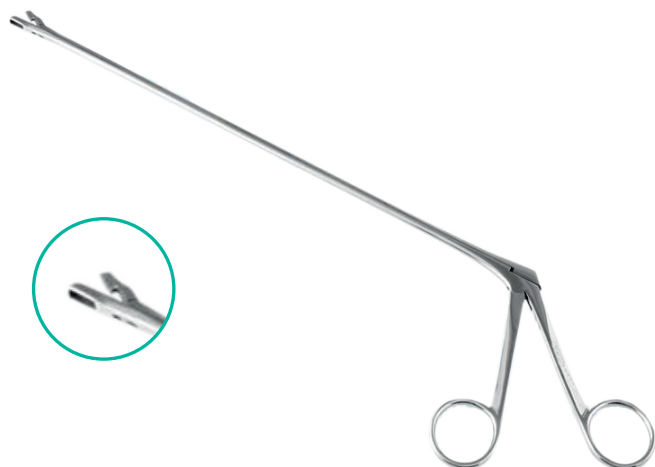

CÓD. 0066 - MATHIEU 20cm PARA BIOPSIA URETRAL
CÓD. 0067 - MATHIEU 28cm PARA BIOPSIA URETRAL

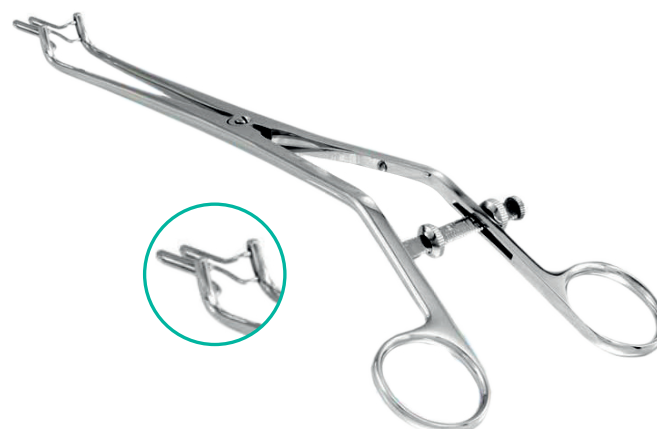

CÓD. 0036 - MENKEN OU KOGAN 27cm PARA ABERTURA DO COLO DO ÚTERO



CÓD. 0254 - MICHEL 12,5cm PARA RETIRAR E COLOCAR AGRAFES



CÓD. 0659 - MARTEL 14cm PARA PERICLANIO

PINÇAS



CÓD. 0372 - MIXTER BABY 14cm (HEMOSTÁTICA)
CÓD. 0373 - MIXTER BABY 16cm (HEMOSTÁTICA)
CÓD. 0255 - MIXTER 18cm (HEMOSTÁTICA)
CÓD. 0256 - MIXTER 20cm (HEMOSTÁTICA)
CÓD. 0257 - MIXTER 22cm (HEMOSTÁTICA)
CÓD. 0258 - MIXTER 24cm (HEMOSTÁTICA)

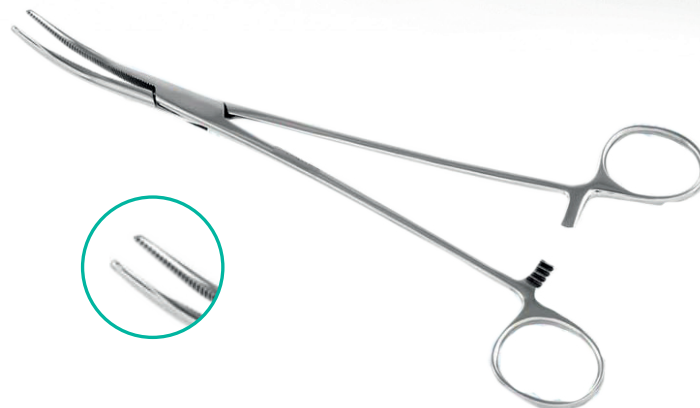

CÓD. 0259 - MOYNIHAN 24cm P/ HISTERECTOMIA



CÓD. 0230 - MUSEUX RETA 24cm OU JACOBS P/ COLO UTERINO

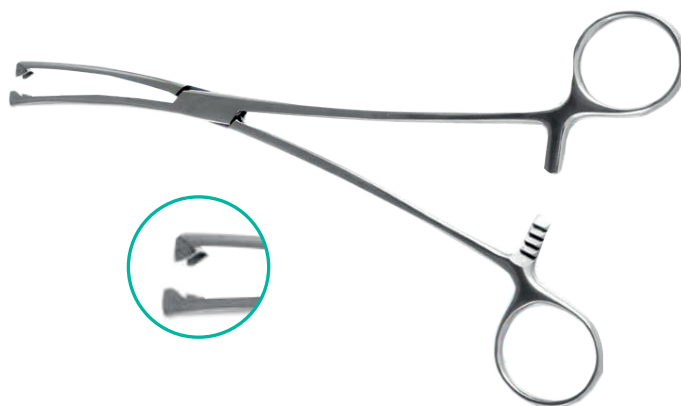

CÓD. 1160 - MUSEUX CURVA 24cm OU JACOBS P/ COLO UTERINO

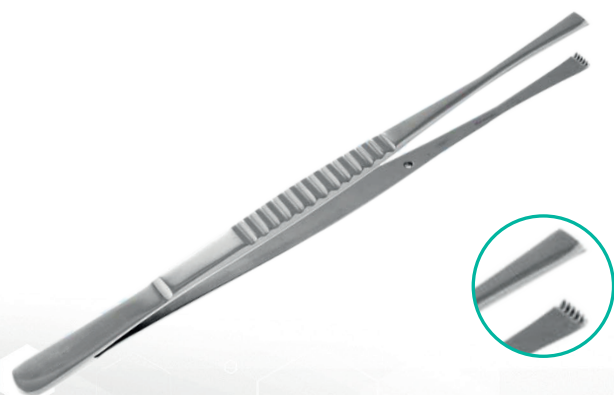

CÓD. 0655 - NELSON 16cm PARA PULMÃO E INTESTINOS
CÓD. 0656 - NELSON 18cm PARA PULMÃO E INTESTINOS
CÓD. 0657 - NELSON 20cm PARA PULMÃO E INTESTINOS



CÓD. 1146 - PINÇA PARA BIOPSIA MICRO 8cm RETA AURICULAR

PINÇAS

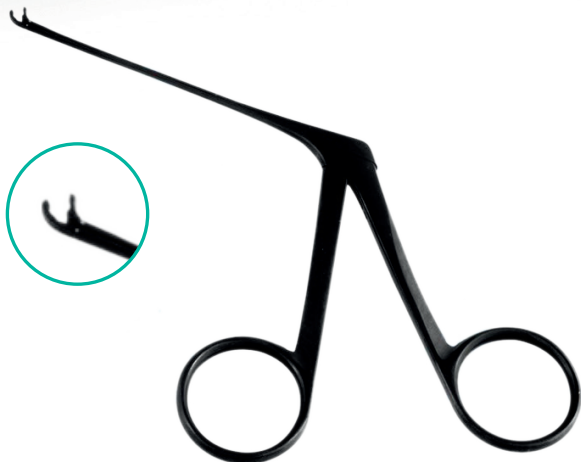

**CÓD. 1147- PINÇA PARA BIOPSIA MICRO 8cm
CURVA PARA CIMA AURICULAR**



**CÓD. 1148- PINÇA PARA BIOPSIA MICRO 8cm
CURVA PARA DIREITA AURICULAR**

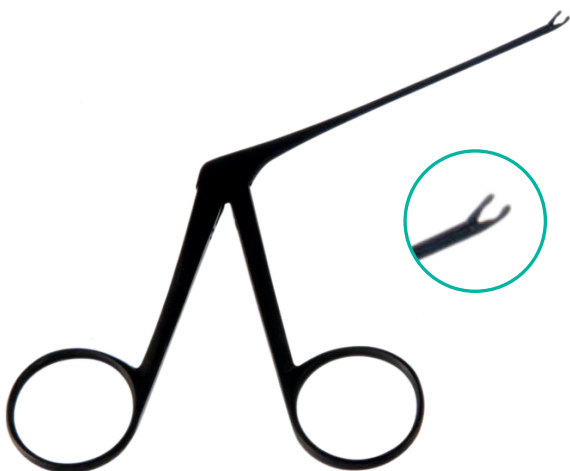

**CÓD. 1149- PINÇA PARA BIOPSIA MICRO 8cm
CURVA PARA ESQUERDA AURICULAR**



**CÓD. 0260 - PATA DE GATO (RUSSA) 15cm P/ TECIDO
CÓD. 0261- PATA DE GATO (RUSSA) 20cm P/ TECIDO**



**CÓD. 0262 - PAYR 20cm CLAMP P/ ESTÔMAGO E INTESTINO
CÓD. 0263 - PAYR 29cm CLAMP P/ ESTÔMAGO E INTESTINO
CÓD. 0264 - PAYR 35cm CLAMP P/ ESTÔMAGO E INTESTINO**



**CÓD. 0265 - PEAN 14cm (HEMOSTÁTICA E CURATIVO)
CÓD. 0266 - PEAN 16cm (HEMOSTÁTICA E CURATIVO)**

PINÇAS



CÓD. 0267 - PELKMANN 24cm PARA CURATIVO UTERINO



**CÓD. 1044 - PENNINGTON 15cm TRIANGULAR (HEMOSTATICA)
CÓD. 0658 - PENNINGTON 20cm TRIANGULAR (HEMOSTATICA)**

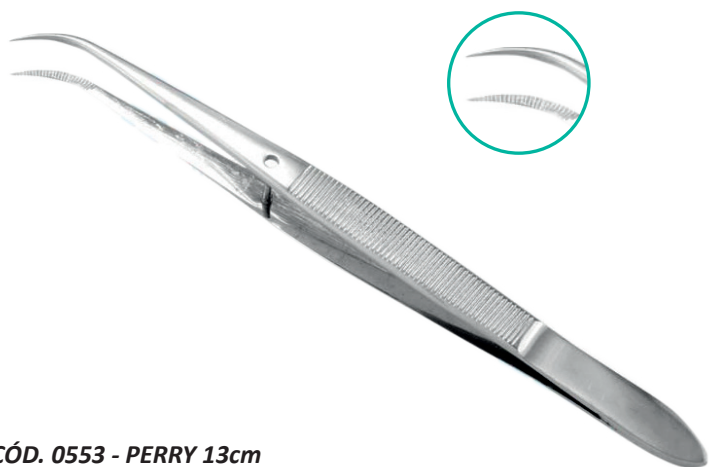

CÓD. 0553 - PERRY 13cm



CÓD. 0268 - POZZI 24cm PARA COLO UTERINO

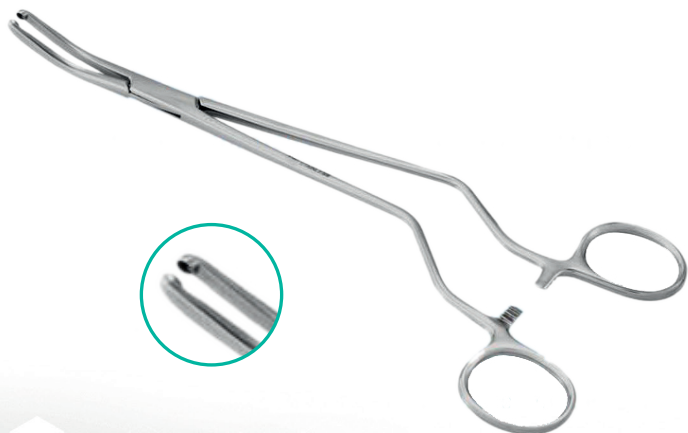

**CÓD. 1049 - PROFESSOR MEDINA 2mm P/ BIOPSIA UTERINA 24cm
CÓD. 0269 - PROFESSOR MEDINA 3mm P/ BIOPSIA UTERINA 24cm
CÓD. 0637- PROFESSOR MEDINA 4mm P/ BIOPSIA UTERINA 24cm
CÓD. 0638- PROFESSOR MEDINA 5mm P/ BIOPSIA UTERINA 24cm**



**CÓD. 0270 - RANDALL PARA CÁLCULO RENAL Nº 1
CÓD. 0271 - RANDALL PARA CÁLCULO RENAL Nº 2
CÓD. 0272 - RANDALL PARA CÁLCULO RENAL Nº 3
CÓD. 0273 - RANDALL PARA CÁLCULO RENAL Nº 4**

PINÇAS



CÓD. 0365 - REINOLD P/ TUBO 18cm (PARA HEMODIALISE)



**CÓD. 0900 - ROCHESTER CARMALT RETA 16cm (HEMOSTATICA)
CÓD. 0902 - ROCHESTER CARMALT RETA 18cm (HEMOSTATICA)
CÓD. 0904 - ROCHESTER CARMALT RETA 20cm (HEMOSTATICA)**



**CÓD. 0901 - ROCHESTER CARMALT CURVA 16cm (HEMOSTATICA)
CÓD. 0903 - ROCHESTER CARMALT CURVA 18cm (HEMOSTATICA)
CÓD. 0905 - ROCHESTER CARMALT CURVA 20cm (HEMOSTATICA)**



**CÓD. 0274 - ROCHESTER PEAN RETA 16cm (HEMOSTATICA)
CÓD. 0276 - ROCHESTER PEAN RETA 18cm (HEMOSTATICA)
CÓD. 0278 - ROCHESTER PEAN RETA 20cm (HEMOSTATICA)
CÓD. 0280 - ROCHESTER PEAN RETA 22cm (HEMOSTATICA)
CÓD. 0282 - ROCHESTER PEAN RETA 24cm (HEMOSTATICA)
CÓD. 1164 - ROCHESTER PEAN RETA 26cm (HEMOSTATICA)
CÓD. 1166 - ROCHESTER PEAN RETA 30cm (HEMOSTATICA)**



**CÓD. 0275 - ROCHESTER PEAN CURVA 16cm (HEMOSTATICA)
CÓD. 0277 - ROCHESTER PEAN CURVA 18cm (HEMOSTATICA)
CÓD. 0279 - ROCHESTER PEAN CURVA 20cm (HEMOSTATICA)
CÓD. 0281 - ROCHESTER PEAN CURVA 22cm (HEMOSTATICA)
CÓD. 0283 - ROCHESTER PEAN CURVA 24cm (HEMOSTATICA)
CÓD. 1165 - ROCHESTER PEAN CURVA 26cm (HEMOSTATICA)
CÓD. 1167 - ROCHESTER PEAN CURVA 30cm (HEMOSTATICA)**

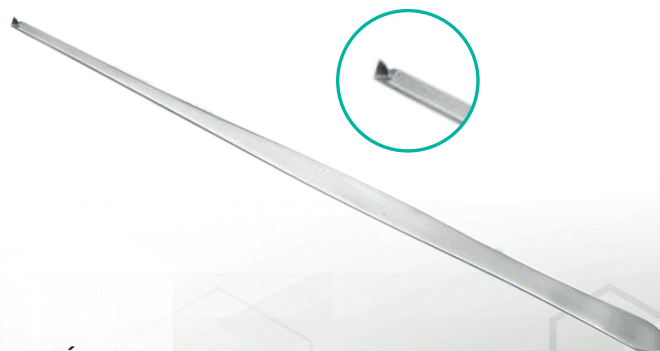

CÓD. 0284 - ROMPE BOLSA 20cm

PINÇAS



CÓD. 0616 - ROWE 23,5 cm ESQUERDA P/ MAXILAR E REDUÇÃO



CÓD. 0617 - ROWE 23,5 cm DIREITA P/ MAXILAR E REDUÇÃO



CÓD. 0285 - RUSKIN 19cm CURVA DUPLA ARTICULAÇÃO



CÓD. 1043- RUSKIN 19cm RETA DUPLA ARTICULAÇÃO

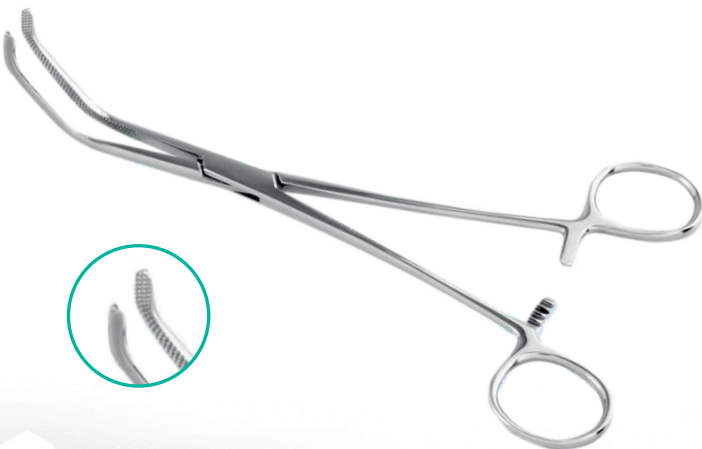

CÓD. 0940 - SATINSKY - BABY/CRUZ 15cm P/ CARDIOVASCULAR
CÓD. 0941 - SATINSKY - SERR/CRUZADA 18cm P/ CARDIOVASCULAR
CÓD. 0942 - SATINSKY - SERR/CRUZADA 20cm P/ CARDIOVASCULAR
CÓD. 0943 - SATINSKY - SERR/CRUZADA 22cm P/ CARDIOVASCULAR
CÓD. 0944 - SATINSKY - SERR/CRUZADA 24cm P/ CARDIOVASCULAR
CÓD. 0945 - SATINSKY - SERR/CRUZADA 26cm P/ CARDIOVASCULAR



CÓD. 0969 - SATINSKY - ATRAUMA 20cm P/ CARDIOVASCULAR
CÓD. 0970 - SATINSKY - ATRAUMA 24cm P/ CARDIOVASCULAR
CÓD. 0971 - SATINSKY - ATRAUMA 26cm P/ CARDIOVASCULAR

PINÇAS



CÓD. 0380 - SCHIMIDT 18 cm RETA P/ AMIGDALAS



CÓD. 0381 - SCHIMIDT 18 cm CURVA P/ AMIGDALAS

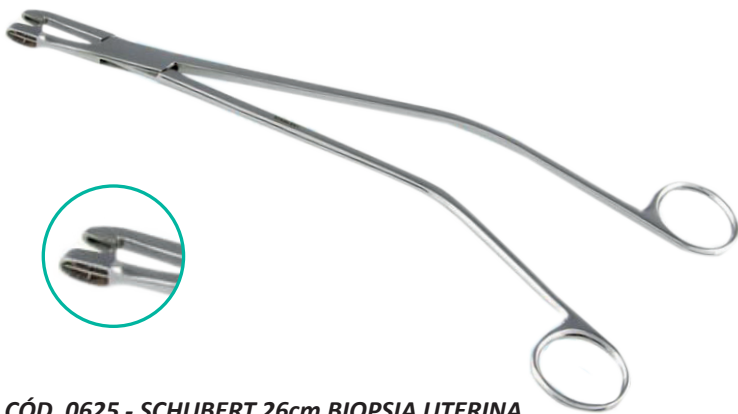

CÓD. 0625 - SCHUBERT 26cm BIOPSIA UTERINA



CÓD. 0626 - SCHUUMACHER 31cm BIOPSIA UTERINA



CÓD. 0404 - SEMB PARA ORTOPEDIA 20cm



CÓD. 0485 - SNELLEN DIREITA 9cm PARA ENCONTRO

PINÇAS



CÓD. 0459 - SENELLEN ESQUERDA 9cm P/ ENTROPIO



CÓD. 0589 - TAKAHASHI 19cm BOCA RETA P/ NARIZ



CÓD. 0590 - TAKAHASHI 19cm BOCA P/ CIMA P/ NARIZ

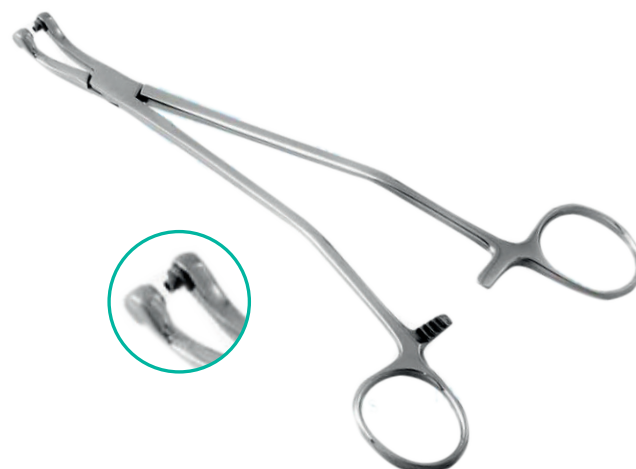

CÓD. 0626 - THOMAS GAYLOR 24cm PARA BIOPSIA

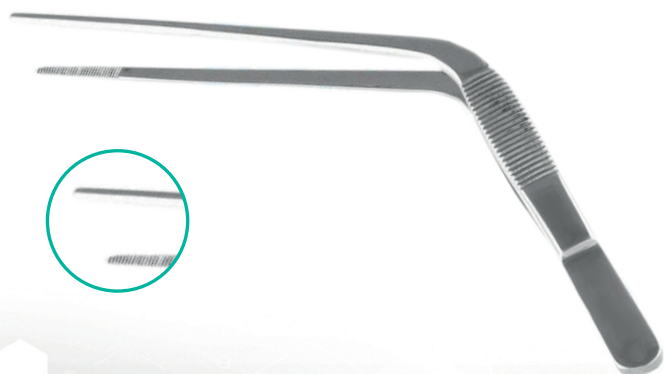

CÓD. 0522 - TROELTSCH 16cm P/ CURATIVO AURICULAR
CÓD. 0523 - TROELTSCH 18cm P/ CURATIVO AURICULAR

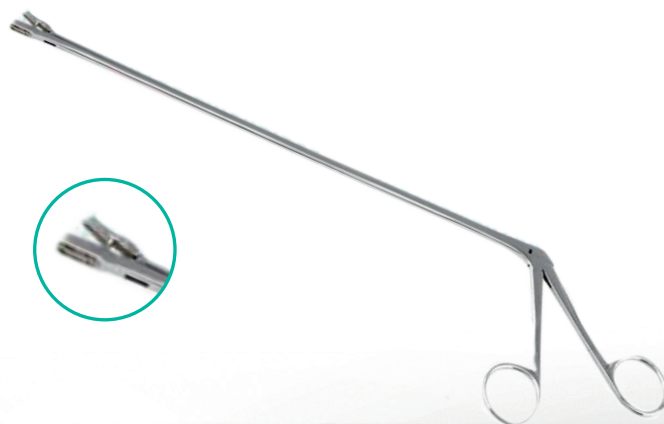

CÓD. 0621 - YEOMAN 28cm BOCA ARREDONDADA P/ BIOPSIA
CÓD. 0622 - YEOMAN 35cm BOCA ARREDONDADA P/ BIOPSIA

PINÇAS



CÓD. 0623 - YEOMAN 28cm BOCA CHATA PAR BIOPSIA



CÓD. 0388 - WERTHEIM CULLEN 22cm P/ HISTERECTOMIA

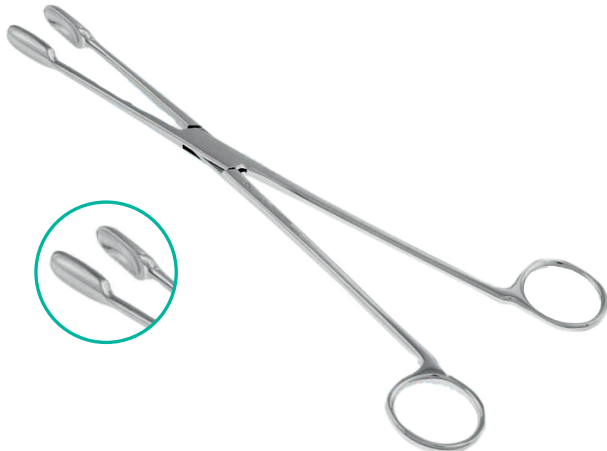

CÓD. 0984 - WINTER 27cm RETA Nº 1 P/ ABORTO E PLACENTA
CÓD. 0287 - WINTER 27cm RETA Nº 2 P/ ABORTO E PLACENTA
CÓD. 0986 - WINTER 27cm RETA Nº 3 P/ ABORTO E PLACENTA

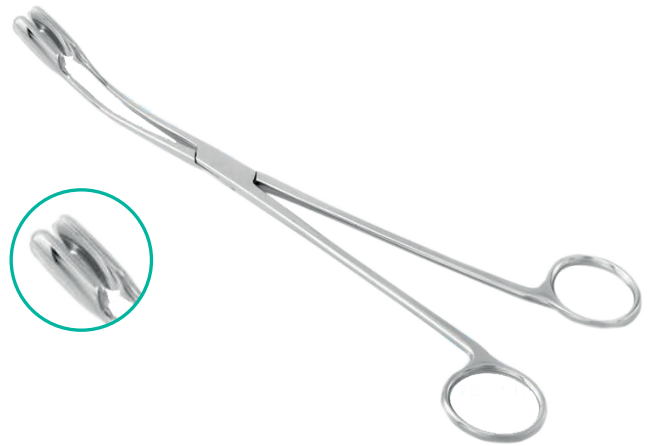

CÓD. 0985 - WINTER 27cm CURVA Nº 1 P/ ABORTO E PLACENTA
CÓD. 0288 - WINTER 27cm CURVA Nº 2 P/ ABORTO E PLACENTA
CÓD. 0987 - WINTER 27cm CURVA Nº 3 P/ ABORTO E PLACENTA

PORTA AGULHAS



CÓD. 0449 - CASTROVIEJO 14cm RETO COM TRAVA

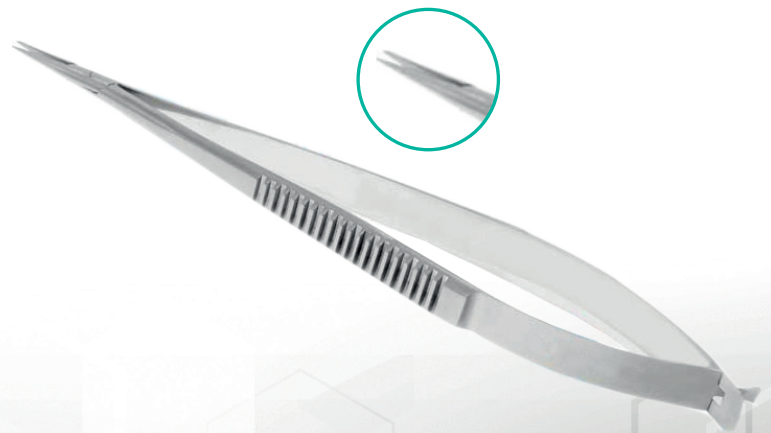

CÓD. 0450 - CASTROVIEJO 154cm RETO SEM TRAVA

PORTA - AGULHAS



CÓD. 0451 - CASTROVIEJO 14cm CURVO COM TRAVA

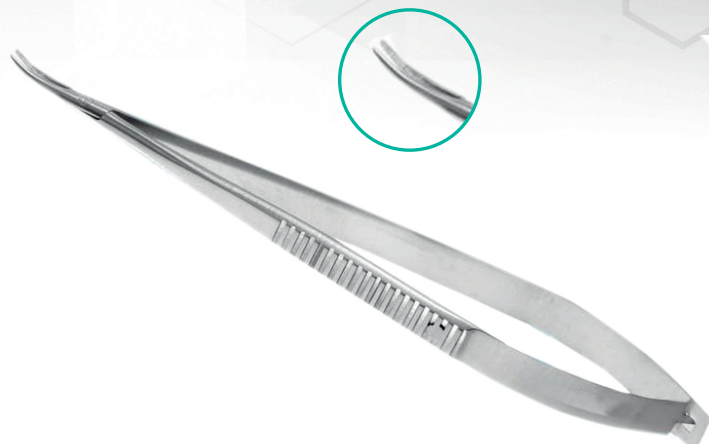

CÓD. 0452 - CASTROVIEJO 15cm CURVO SEM TRAVA



CÓD. 0289 - CRILE WOOD 15cm P/ SUTURA
CÓD. 1050 - CRILE WOOD 16cm P/ SUTURA
CÓD. 0290 - CRILE WOOD 18cm P/ SUTURA



CÓD. 0291 - DERF 12cm PARA SUTURA



CÓD. 0292 - ERMOLD 20cm



CÓD. 1154 - MATHIEU 11cm PARA SUTURA
CÓD. 0293 - MATHIEU 14cm PARA SUTURA
CÓD. 0294 - MATHIEU 17cm PARA SUTURA
CÓD. 0295 - MATHIEU 20cm PARA SUTURA

PORTA - AGULHAS



CÓD. 0296 - MAYO HEGAR 14cm PARA SUTURA
 CÓD. 1048 - MAYO HEGAR 15cm PARA SUTURA
 CÓD. 0530 - MAYO HEGAR 16cm PARA SUTURA
 CÓD. 0297 - MAYO HEGAR 18cm PARA SUTURA
 CÓD. 0298 - MAYO HEGAR 20cm PARA SUTURA
 CÓD. 0070 - MAYO HEGAR 25cm PARA SUTURA
 CÓD. 1157 - MAYO HEGAR 30cm PARA SUTURA



CÓD. 0930 - PORTA AGULHA P/ FIO DE AÇO 16cm
 CÓD. 0931 - PORTA AGULHA P/ FIO DE AÇO 20cm

PORTA - AGULHAS DE TUNGSTÊNIO

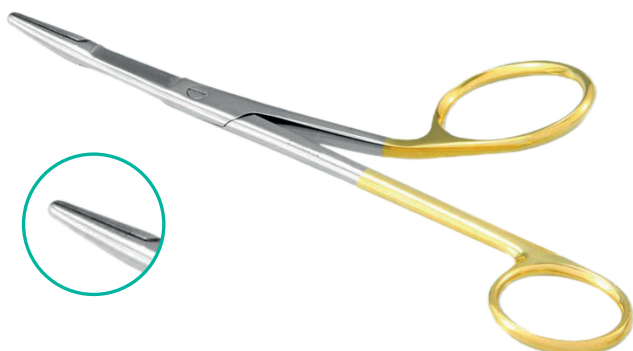

CÓD. 0573 - GILLIES 16cm C/ WIDIA PARA SUTURA

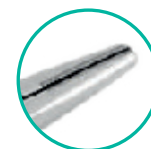

CÓD. 0359 - MAYO HEGAR 12cm C/ WIDIA P/ SUTURA
 CÓD. 0360 - MAYO HEGAR 14cm C/ WIDIA P/ SUTURA
 CÓD. 0361 - MAYO HEGAR 16cm C/ WIDIA P/ SUTURA
 CÓD. 0362 - MAYO HEGAR 18cm C/ WIDIA P/ SUTURA
 CÓD. 0363 - MAYO HEGAR 20cm C/ WIDIA P/ SUTURA



CÓD. 0574 - MATHIEU 14cm C/ WIDIA P/ SUTURA
 CÓD. 0575 - MATHIEU 17cm C/ WIDIA P/ SUTURA
 CÓD. 0576 - MATHIEU 20cm C/ WIDIA P/ SUTURA



CÓD. 0572 - OLSEN HEGAR 14cm C/ WIDIA P/ SUTURA

PORTA GILETE

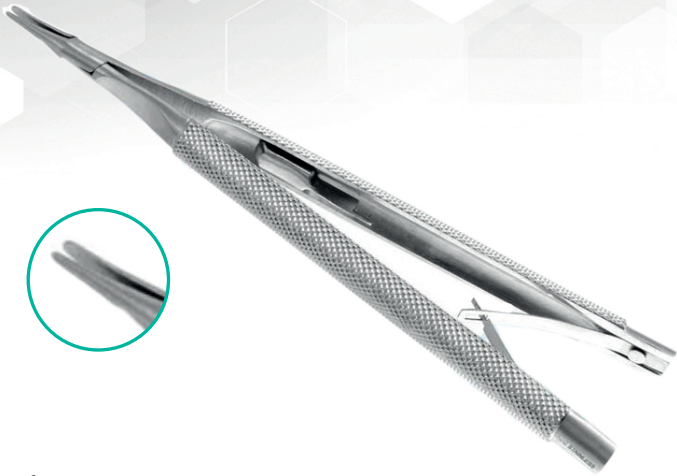

CÓD. 0443 - CASTROVIEJO 12,5cm FINO

RASPAS

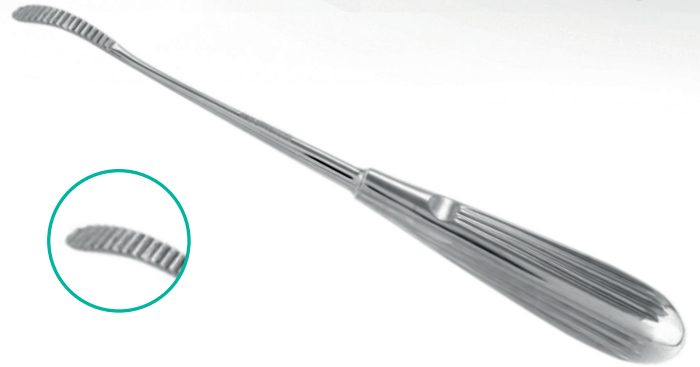

CÓD. 0927 - AUFRICHT 21cm DENTES P/ BAIXO P/ PLÁSTICA NASAL

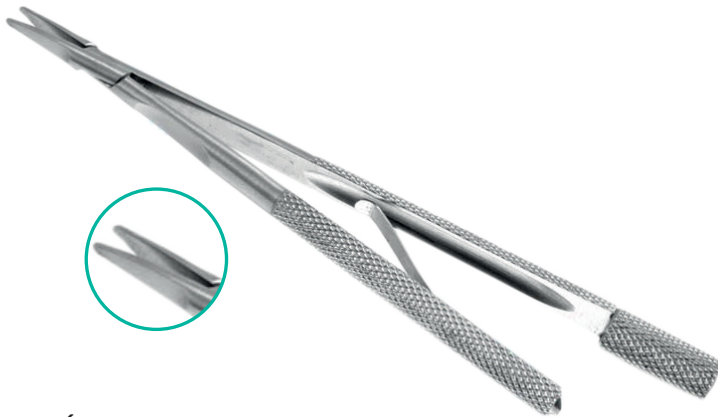

CÓD. 0444 - CASTROVIEJO 12,5cm GROSSO

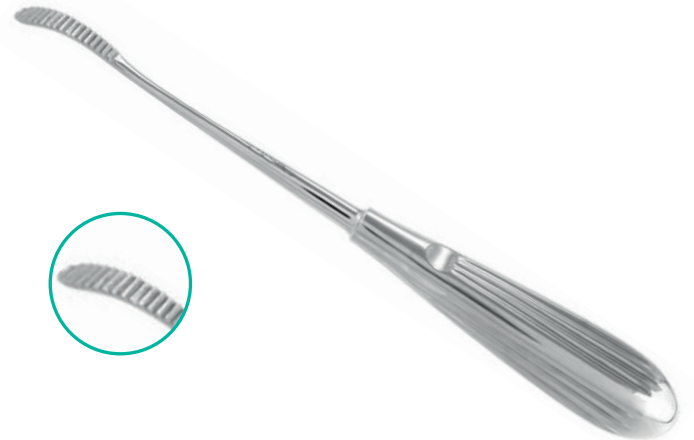

CÓD. 0926 - AUFRICHT 24cm P/ CIMA P/ PLÁSTICA NASAL

PUNCH



CÓD. 0415 - KEYS 2mm P/ BIOPSIA DE PELE
CÓD. 0416 - KEYS 3mm P/ BIOPSIA DE PELE
CÓD. 0417 - KEYS 4mm P/ BIOPSIA DE PELE
CÓD. 0418 - KEYS 5mm P/ BIOPSIA DE PELE
CÓD. 0419 - KEYS 6mm P/ BIOPSIA DE PELE
CÓD. 0420 - KEYS 7mm P/ BIOPSIA DE PELE
CÓD. 0421 - KEYS 8mm P/ BIOPSIA DE PELE

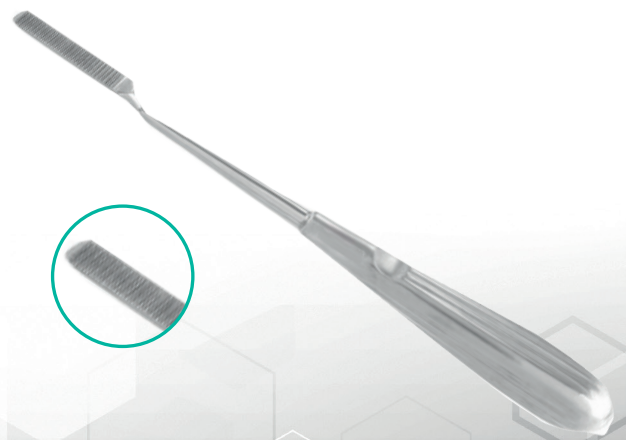

CÓD. 0925 - COTTLE 21cm P/ PLÁSTICA NASAL

RASPAS

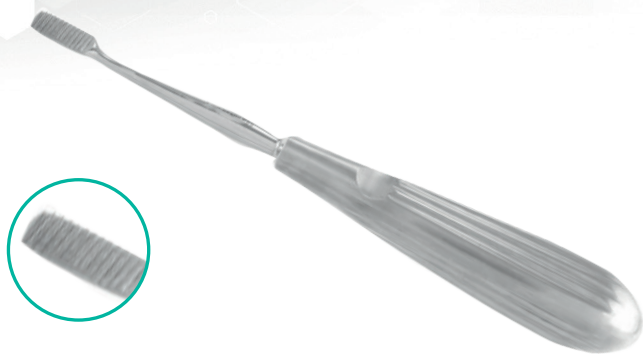

CÓD. 0928 - LEWIS 18cm DENTE FINO P/ PLÁSTICA NASAL

ROTATIVA



CÓD. 0037 - BALIU 18cm PARA BIOPSIA UTERINA

RUGINAS

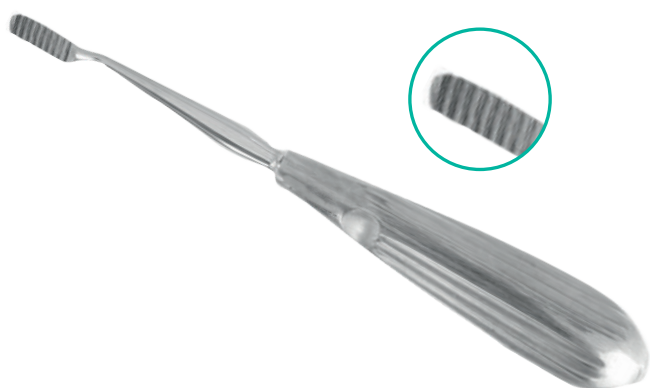

CÓD. 0929 - LEWIS 18cm DENTE GROSSO P/ PLÁSTICA NASAL



CÓD. 1172 - DOYEN 17cm ESQUERDA

RETOSCÓPIO



CÓD. 1055 - PITANGA Nº1 (19 x 155mm)
CÓD. 1056 - PITANGA Nº2 (22 x 155mm)
CÓD. 1057 - PITANGA Nº3 (25x 155mm)

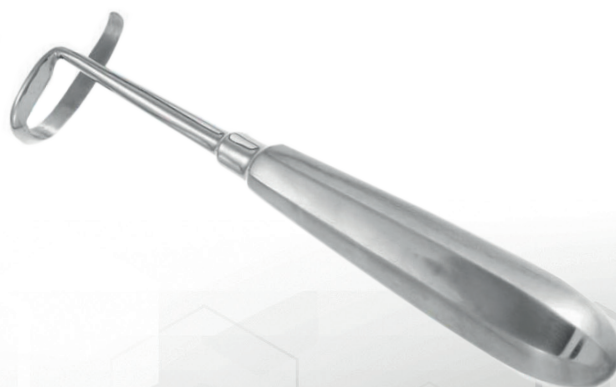

CÓD. 1120 - DOYEN 17cm DIREITA

RUGINAS



CÓD. 0299 - FARABEU 14cm RETA P/ CIRURGIA ÓSSEA

SACA-FIBROMA



CÓD. 0301 - DOYEN 17cm C/ ESPESSURA 3mm

SERRAS



**CÓD. 0440 - GIGLI 30cm P/ AMPUTAÇÃO
CÓD. 0441 - GIGLI 40cm P/ AMPUTAÇÃO
CÓD. 0442 - GIGLI 50cm P/ AMPUTAÇÃO**



CÓD. 0300 - FARABEU 14cm CURVA P/ CIRURGIA ÓSSEA

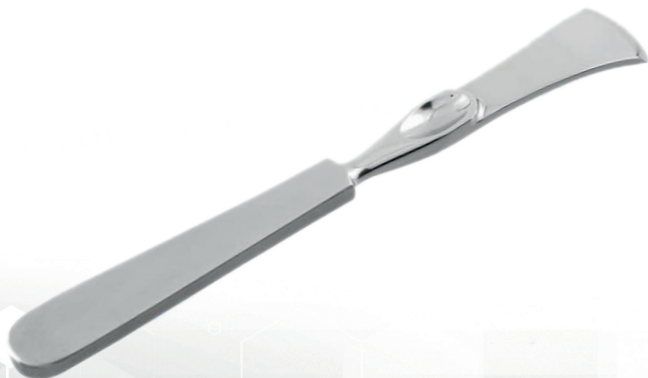

**CÓD. 0400 - LAMBOTTE 15cm P/ CIRURGIA ÓSSEA
CÓD. 0401 - LAMBOTTE 20cm P/ CIRURGIA ÓSSEA**



CÓD. 0908 - CHARRIERE 30cm P/ AMPUTAÇÃO

SERRAS



CÓD. 0909 - LANGENBECK 23cm P/ CIRURGIA ÓSSEA



**CÓD. 1051 - MATHIEU 20cm C/ 3 LAMINAS
PARA AMPUTAÇÃO**
**CÓD. 0304 - MATHIEU 33cm C/ 3 LAMINAS
PARA AMPUTAÇÃO**



CÓD. 0305 - WEISS 25cm P/ AMPUTAÇÃO



CÓD. 0907 - WIGMORE 19cm PARA GESSO



CÓD. 0924 - JOSEPH 19cm ESQUERDA P/ CIRURGIA NASAL

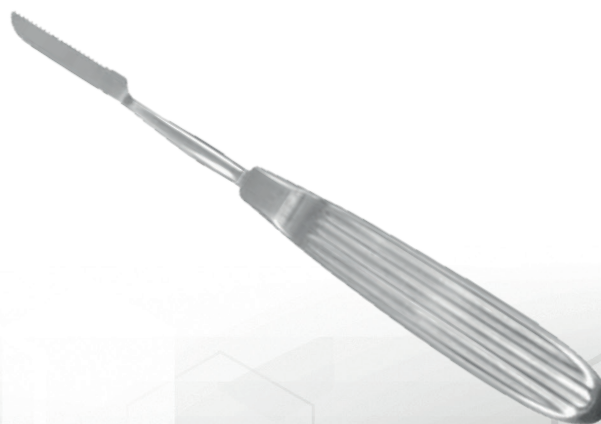

CÓD. 0923 - JOSEPH 19cm DIREITA P/ CIRURGIA NASAL

SERRAS - NO



CÓD. 0306 - BRUENINGS 29cm C/ CREMALHEIRA P/ AMIGDALAS

SONDAS



CÓD. 1074 - ITARD 13cm C/ FURO DE 1mm AURICULAR
CÓD. 1075 - ITARD 13cm C/ FURO DE 2mm AURICULAR

TENTACANULA



CÓD. 0308 - TENTACANULA 15cm SONDA ACANELADA

TESOURAS



CÓD. 0038 - BALIU 20cm UTERINA

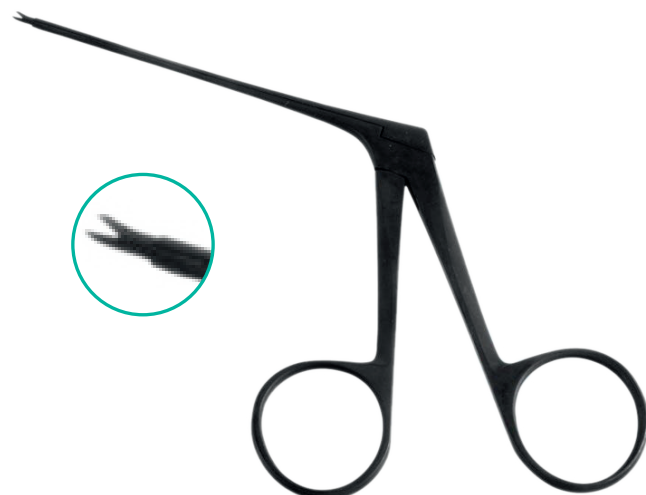

CÓD. 1150 - BELLUCCI MICRO 8cm RETA AURICULAR



CÓD. 1151 - BELLUCCI MICRO 8cm CURVA P/ CIMA AURICULAR

TESOURAS



**CÓD. 1153 - BELLUCCI MICRO 8cm CURVA
PARA ESQUERDA AURICULAR**

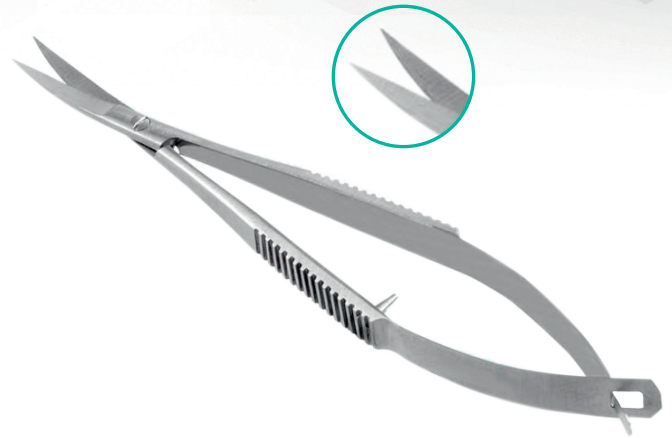

**CÓD. 0446 - CASTROVIEJO 9cm CURVA
PARA MICRO CIRURGIA**



**CÓD. 0309 - CIRURGICA 15cm RETA FINA/FINA
CÓD. 0315 - CIRURGICA 17cm RETA FINA/FINA**



**CÓD. 0312 - CIRURGICA 15cm CURVA FINA/FINA
CÓD. 0318 - CIRURGICA 17cm CURVA FINA/FINA**



**CÓD. 1152 - BELLUCCI MICRO 8cm CURVA
P/ DIREITA AURICULAR**



**CÓD. 0311 - CIRURGICA 15cm RETA ROMBA/ROMBA
CÓD. 0317 - CIRURGICA 17cm RETA ROMBA/ROMBA**

TESOURAS



CÓD. 0310 - CIRURGICA 15cm RETA FINA/ROMBA
CÓD. 0316 - CIRURGICA 17cm RETA FINA/ROMBA



CÓD. 0313 - CIRURGICA 15cm CURVA FINA/ROMBA
CÓD. 0319 - CIRURGICA 17cm CURVA FINA/ROMBA



CÓD. 0899 - ENTEROTOMO 21cm
PARA ANATOMIA E ENTEROTOMIA



CÓD. 0645 - GOLDMAN FOX 13cm SERRILHADA
PARA PERIODONTIA



CÓD. 0314 - CIRURGICA 15cm CURVA ROMBA/ROMBA
CÓD. 0320 - CIRURGICA 17cm CURVA ROMBA/ROMBA



CÓD. 0567 - HEYMANN ANGULADA 18cm COM
SERRILHA PARA CIRURGIA NASAL

TESOURAS



CÓD. 0898 - IRIS OU GENGIVA CURVA 8cm
CÓD. 0322 - IRIS OU GENGIVA CURVA 12m



CÓD. 0391 - JOSEPH 14cm RETA PARA USO GERAL



CÓD. 0392 - JOSEPH 14cm CURVA PARA USO GERAL



CÓD. 0641 - KILNER 12cm P/ CIRURGIA PLÁSTICA



CÓD. 0897 - IRIS OU GENGIVA RETA 8cm
CÓD. 0321 - IRIS OU GENGIVA RETA 12m



CÓD. 0323 - LISTER 14cm PARA BANDAGEM
CÓD. 0324 - LISTER 17cm PARA BANDAGEM
CÓD. 0325 - LISTER 19cm PARA BANDAGEM

TESOURAS



CÓD. 0326 - MAYO STILLE 15cm RETA
CÓD. 0328 - MAYO STILLE 17cm RETA
CÓD. 0389 - MAYO STILLE 19cm RETA



CÓD. 0327 - MAYO STILLE 15cm CURVA
CÓD. 0329 - MAYO STILLE 17cm CURVA
CÓD. 0390 - MAYO STILLE 19cm CURVA



CÓD. 0330 - METZEMBAUM 12cm RETA
CÓD. 0332 - METZEMBAUM 15cm RETA
CÓD. 0334 - METZEMBAUM 18cm RETA
CÓD. 0336 - METZEMBAUM 20cm RETA
CÓD. 0338 - METZEMBAUM 25cm RETA
CÓD. 0892 - METZEMBAUM 28cm RETA
CÓD. 0334 - METZEMBAUM 30cm RETA



CÓD. 0331 - METZEMBAUM 12cm CURVA
CÓD. 0333 - METZEMBAUM 15cm CURVA
CÓD. 0335 - METZEMBAUM 18cm CURVA
CÓD. 0337 - METZEMBAUM 20cm CURVA
CÓD. 0339 - METZEMBAUM 25cm CURVA
CÓD. 0893 - METZEMBAUM 28cm CURVA
CÓD. 0895 - METZEMBAUM 30cm CURVA



CÓD. 0326 - MAYO STILLE 15cm RETA C/ SERRILHA
PARA CARTILAGEM



CÓD. 0465 - NOYES IRIS 12cm RETA
PARA MICRO CIRURGIA

TESOURAS



CÓD. 0340 - OURO RETA 10cm P/ CORTE METAL



CÓD. 0341 - OURO CURVA 10cm P/ CORTE METAL



CÓD. 0642 - POTTS - SMITH 19cm 25° P/ VASCULAR



CÓD. 0643 - POTTS - SMITH 19cm 40° P/ VASCULAR



CÓD. 0457 - NOYES IRIS 12cm CURVA
PARA MICRO CIRURGIA



CÓD. 0644 - PORRS - SMITH 19cm 60° P/ VASCULAR

TESOURAS



CÓD. 0342 - SIMS 20cm RETA UTERINA



CÓD. 0343 - SIMS 20cm CURVA UTERINA



CÓD. 0889 - SMITH 20cm P/ BANDAGEM

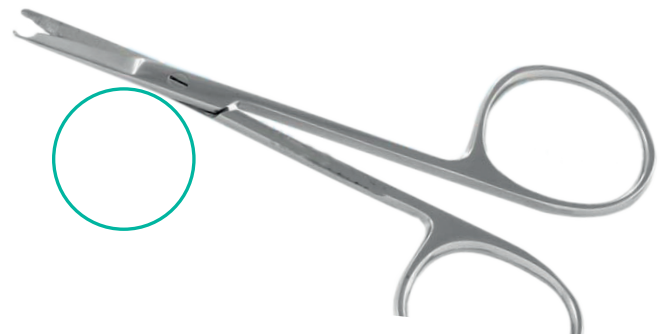

CÓD. 0344 - SPENCER 9cm RETA P/ RETIRAR PONTOS
CÓD. 0646 - SPENCER 12cm RETA P/ RETIRAR PONTOS



**CÓD. 1155 - SCHUMACHER 15,5cm
PARA CORDÃO UMBILICAL**



CÓD. 0345 - STEVENS 10cm RETA

TESOURAS



**CÓD. 0896 - TESOURA PARA CORDÃO UBBILICAL
10 cm MODELO U.S.A**



CÓD. 0447 - VANNAS 8 cm RETA P/ MICRO CIRURGIA



CÓD. 0448 - VANNAS 8 cm CURVA P/ MICRO CIRURGIA



CÓD. 0454 - WESTCOTT 11cm RETA P/ MICRO CIRURGIA



CÓD. 0346 - STEVENS 10cm CURVA



CÓD. 0455 - WESTCOTT 11cm CURVA P/ MICRO CIRURGIA

VÁLVULAS



COD. 0353 - DOYEN 45 X 90 cm P/ GINECOLOGIA
CÓD. 0354 - DOYEN 45 X 120 cm P/ GINECOLOGIA
CÓD. 0605 - DOYEN 45 X 60 cm P/ GINECOLOGIA
CÓD. 0606 - DOYEN 45 X 90 cm P/ GINECOLOGIA
CÓD. 0607 - DOYEN 45 X 120 cm P/ GINECOLOGIA



CÓD. 0351 - DOYEN SUB-PUBIANA



CÓD. 0355 - VALVULA P/ AFASTADOR BAUFOR ABDOMINAL CURVA 45x80



CÓD. 0977 - VALVULA P/ AFASTADOR BAUFOR ABDOMINAL RETA 70x100



CÓD. 0350 - AUVARD C/ PESO 38x80 P/ GINECOLOGIA

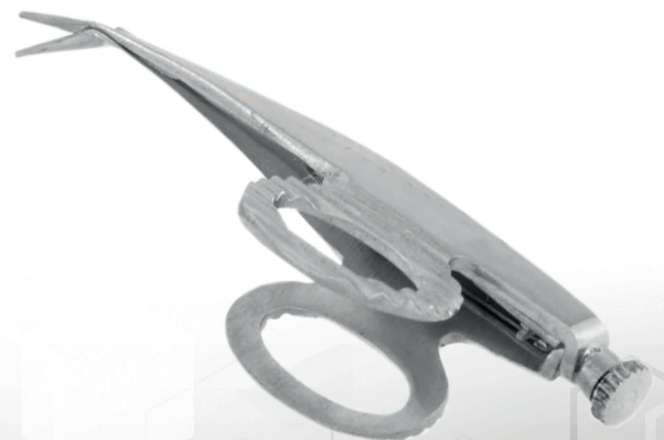

CÓD. 1073 - BARRAQUER 5,5cm C/ PONTA ANGULO 7mm

BALDE, CUBAS E ESTOJOS

BALDE



CÓD. 2003 - BALDE 23 X 18cm - 5.000ml

COMADRE



CÓD. 2010 - COMADRE 40 X 30 cm TIPO PA 2.000ml

BANDEJAS



CÓD. 2004 - BANDEJA 22 X 09 X 1,5 cm
CÓD. 2005 - BANDEJA 22 X 12 X 1,5 cm
CÓD. 2006 - BANDEJA 22 X 17 X 1,5 cm
CÓD. 2007- BANDEJA 24 X 18 X 1,5 cm

CUBAS



CÓD. 2011 - CUBA RED. 08 X 3,6 P/ ASSEPSIA 160ml
CÓD. 2012 - CUBA RED. 09 X 4,5 P/ ASSEPSIA 240ml
CÓD. 2013 - CUBA RED. 10,5 X 4,5 P/ ASSEPSIA 340ml
CÓD. 2014 - CUBA RED. 13,5 X 4,5 P/ ASSEPSIA 530ml

BANDEJAS



CÓD. 2008 - BANDEJA 30 X 20 X 04 cm
CÓD. 2009 - BANDEJA 49 X 33 cm p/ EQUIPO

CUBAS RETAS



CÓD. 2015 - CUBA RET. / BANDEJA 35 X 25 X 04cm
CÓD. 2016 - CUBA RET. / BANDEJA 45 X 32 X 4,5cm

CUBA RIM



CÓD. 2017 - CUBA RIM 26 X 12 X 740 ml

ESTOJOS



CÓD. 2018 - ESTOJO 18 X 07 X 02 cm
CÓD. 2019 - ESTOJO 18 X 08 X 03 cm
CÓD. 2020 - ESTOJO 18 X 08 X 05 cm
CÓD. 2021 - ESTOJO 20 X 10 X 02 cm
CÓD. 2022 - ESTOJO 20 X 10 X 03 cm
CÓD. 2023 - ESTOJO 20 X 10 X 05 cm
CÓD. 2024 - ESTOJO 26 X 12 X 06 cm
CÓD. 2025 - ESTOJO 28 X 14 X 06 cm
CÓD. 2026 - ESTOJO 32 X 16 X 08 cm
CÓD. 2028 - ESTOJO 36 X 22 X 09cm
CÓD. 2029 - ESTOJO 42 X 18 X 09 cm
CÓD. 2030 - ESTOJO 42 X 28 X 12cm

ESTOJOS PERFURADOS



CÓD. 2031- ESTOJO PERFURADO 18 X 07 X 02cm AUTOCLAVAVEL
CÓD. 2032 - ESTOJO PERFURADO 18 X 08 X 03cm AUTOCLAVAVEL
CÓD. 2033 - ESTOJO PERFURADO 18 X 08 X 05cm AUTOCLAVAVEL
CÓD. 2034 - ESTOJO PERFURADO 20 X 10 X 02cm AUTOCLAVAVEL
CÓD. 2035 - ESTOJO PERFURADO 20 X 10 X 03cm AUTOCLAVAVEL
CÓD. 2036 - ESTOJO PERFURADO 20 X 10 X 05cm AUTOCLAVAVEL
CÓD. 2037 - ESTOJO PERFURADO 26 X 12 X 06cm AUTOCLAVAVEL
CÓD. 2038 - ESTOJO PERFURADO 28 X 14 X 06cm AUTOCLAVAVEL
CÓD. 2039 - ESTOJO PERFURADO 32 X 16 X 08cm AUTOCLAVAVEL
CÓD. 2040 - ESTOJO PERFURADO 36 X 22 X 09cm AUTOCLAVAVEL
CÓD. 2041 - ESTOJO PERFURADO 42 X 18 X 09cm AUTOCLAVAVEL
CÓD. 2042 - ESTOJO PERFURADO 42 X 28 X 12cm AUTOCLAVAVEL

Dentre os valores que a empresa preconiza, o cliente e sua satisfação estão sempre em primeiro lugar. Um dos diferenciais que a ASCAMAS mais valoriza é justamente a qualidade de seus produtos e a transparência na relação entre nossos colaboradores e clientes.

A nossa história conta o quanto temos trabalhado para alcançar melhorias que permitam a todos trilhar um caminho de sucesso.

Agradecemos por você ter escolhido a ASCAMAS, conte com nossa equipe para te atender!

Equipe ASCAMAS



